



HF-Performer Intelligent for TL5 HE/HO lamps

HF-Pi 1 28/35/49/80 TL5 EII

HF-Performer Intelligent for Master and ECO TL5 HE/HO, TL-D and PL-L lamps. HF-Performer Intelligent features automatic recognition of the connected lamp and is independently able to adjust its operation parameters exactly to the respective lamp. This results in a substantial benefit, especially for T5 lamps, as it means TL5 HE and HO lamps of the same length can be interchanged. With a choice of seven ballasts, the customer is able to handle efficiently every possible combination of Master TL5 and Eco, TL-D, and PL-L lamps. The ballast is primarily designed for Indoor application. For outdoor application, the luminaire should be minimum Classland need to be sufficiently protected against water & dust. The installation should also be guard against any lightning surge or any other necessary electrical protection as deemed in such typical installation & application.

Product data

Operating and Electrical	
Input Voltage	220 to 240 V
Line Frequency	50 to 60 Hz
Input Frequency	50 to 60 Hz
Earth Leakage Current (Max)	0.5 mA
Inrush Current Width	0.35 ms
Inrush Current Peak (Max)	31 A
Number of Products on MCB (16A Type B) (Nom)	12

Wiring	
Connector Type Input Terminals	Insert
Connector Type Output Terminals	Insert

Temperature	
Ambient temperature range	-25 °C to 50 °C
T-Case Lifetime (Nom)	75 °C
T-Case Maximum (Max)	75 °C

HF-Performer Intelligent for TL5 HE/HO lamps

Mechanical and Housing	
Housing	L360x30x22
Approval and Application	
Ingress protection code	IP20 [Finger-protected]
Energy Efficiency Index	A2 BAT
Safety Standard	IEC 61347-2-3
Environmental Standard	ISO 14001
Approval Marks	CE marking ENEC certificate VDE-EMV certificate
Product Data	
Order product name	HF-Pi 1 28/35/49/80 TL5 EII

Full product name	HF-Pi 1 28/35/49/80 TL5 EII
Full product code	872790086249200
Order code	913700652566
Material Nr. (12NC)	913700652566
Numerator - Quantity Per Pack	1
Net Weight (Piece)	0.247 kg
EAN/UPC - Product/Case	8711500881182
Numerator - Packs per outer box	12
EAN/UPC - Case	8727900862492

Dimensional drawing

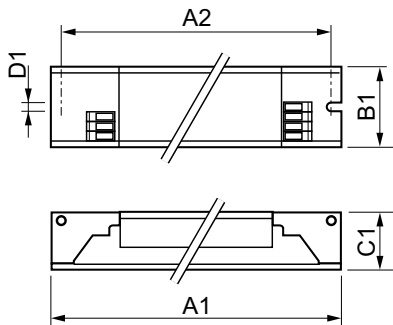

Product	D1	C1	A1	A2	B1
HF-Pi 1 28/35/49/80 TL5 EII	4.2 mm	22 mm	360 mm	350 mm	30 mm

