



# Perfect sparkle, trendy design

## MasterColor CDM-R111 Elite

MasterColor CDM-R111 Elite combines the trendy look of 111 mm aluminum-reflector halogen lamps with the long life, high energy efficiency and crisp white light of MasterColor CDM.

### Benefits

- Crisp white sparkling light
- Easy installation
- Less glare, comfort for shoppers and staff

### Features

- High lamp efficacy
- Long lamp lifetime compared to incandescent and halogen lamps
- The ceramic discharge tube is optimally positioned and stable in the reflector
- UV-block burner capsule
- Anti-glare cap design

### Application

- Accent and decorative lighting: display lighting with sparkling, theatrical effects, even in surroundings with very high background ambient light levels, such as shops windows
- General lighting: in downlighters, a warm and comfortable atmosphere can be created

### Warnings and Safety

- Control gear must include end-of-life protection (IEC61167, IEC 62035)
- Use only with electronic control gear. 35W/930 lamps may also use electromagnetic gear

**PHILIPS**

Related products



CDM-R111 Elite GX8.5

Dimensional drawing

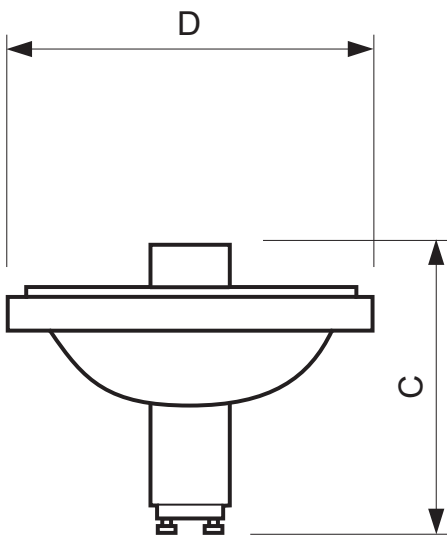

MasterColor CDM-R111 Elite 50W/930 GX8.5 10D

Product	C (Max)	D (Max)
CDM-R111 Elite 50W/930 10D	95	111
CDM-R111 Elite 50W/930 24D	95	111
CDM-R111 Elite 50W/930 40D	95	111
CDM-R111 Elite 35W/930 10D	95	111
CDM-R111 Elite 35W/930 24D	95	111
CDM-R111 Elite 35W/930 40D	95	111
CDM-R111 Elite 70W/930 10D	95	111
CDM-R111 Elite 70W/930 24D	95	111
CDM-R111 Elite 70W/930 40D	95	111

General Characteristics (1/2)

Order code	Full product name	Base	Bulb	Bulb Finish	Operating Position	Life to 5% failures EM	Life to 5% failures EL	Life to 10% failures EM	Life to 10% failures EL	Life to 20% failures EM	Life to 20% failures EL
928194205306	MasterColor CDM-R111 Elite 50W/930 GX8.5 10D	GX8.5	R111	Reflector	Universal	hr	8000 hr	hr	9500 hr	hr	10500 hr
928194305306	MasterColor CDM-R111 Elite 50W/930 GX8.5 24D	GX8.5	R111	Reflector	Universal	hr	8000 hr	hr	9500 hr	hr	10500 hr
928194405306	MasterColor CDM-R111 Elite 50W/930 GX8.5 40D	GX8.5	R111	Reflector	Universal	hr	8000 hr	hr	9500 hr	hr	10500 hr
928195305306	MasterColor CDM-R111 Elite 35W/930 GX8.5 10D	GX8.5	R111	Reflector	Universal	5000 hr	8000 hr	5500 hr	9500 hr	6000 hr	10500 hr
928195405306	MasterColor CDM-R111 Elite 35W/930 GX8.5 24D	GX8.5	R111	Reflector	Universal	5000 hr	8000 hr	5500 hr	9500 hr	6000 hr	10500 hr
928195505306	MasterColor CDM-R111 Elite 35W/930 GX8.5 40D	GX8.5	R111	Reflector	Universal	5000 hr	8000 hr	5500 hr	9500 hr	6000 hr	10500 hr
928195605306	MasterColor CDM-R111 Elite 70W/930 GX8.5 10D	GX8.5	R111	Reflector	Universal	hr	8000 hr	hr	9500 hr	hr	10500 hr
928195705306	MasterColor CDM-R111 Elite 70W/930 GX8.5 24D	GX8.5	R111	Reflector	Universal	hr	8000 hr	hr	9500 hr	hr	10500 hr
928195805306	MasterColor CDM-R111 Elite 70W/930 GX8.5 40D	GX8.5	R111	Reflector	Universal	hr	8000 hr	hr	9500 hr	hr	10500 hr

General Characteristics (2/2)

Order code	Full product name	Avg. Life	Avg. Hrs. Life
928194205306	MasterColor CDM-R111 Elite 50W/930 GX8.5 10D	hr	12000 hr
928194305306	MasterColor CDM-R111 Elite 50W/930 GX8.5 24D	hr	12000 hr
928194405306	MasterColor CDM-R111 Elite 50W/930 GX8.5 40D	hr	12000 hr
928195305306	MasterColor CDM-R111 Elite 35W/930 GX8.5 10D	7500 hr	12000 hr
928195405306	MasterColor CDM-R111 Elite 35W/930 GX8.5 24D	7500 hr	12000 hr

Order code	Full product name	Avg. Life	Avg. Hrs. Life
928195505306	MasterColor CDM-R111 Elite 35W/930 GX8.5 40D	7500 hr	12000 hr
928195605306	MasterColor CDM-R111 Elite 70W/930 GX8.5 10D	hr	12000 hr
928195705306	MasterColor CDM-R111 Elite 70W/930 GX8.5 24D	hr	12000 hr
928195805306	MasterColor CDM-R111 Elite 70W/930 GX8.5 40D	hr	12000 hr

Installation diagrams

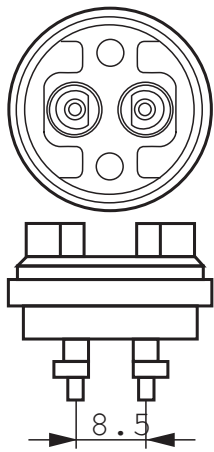

GX8.5

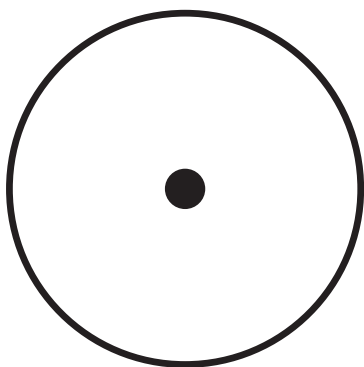

any

## Light Technical Characteristics (1/2)

Order code	Full product name	Beam Description	Beam Angle	Approx. MBCP	Color Code	Color Rendering Index	Color Designation	Color Temperature	Forward Luminous Output	Forward Luminous Efficacy	LLMF - end nominal lifetime
928194205306	MasterColor CDM-R111 Elite 50W/930 GX8.5 10D	Spot	10 D	46500 cd	930	88 (min), 91 (nom) Ra8	Warm White	3000 K	1850 Lm	37 Lm/W	70 %
928194305306	MasterColor CDM-R111 Elite 50W/930 GX8.5 24D	Narrow Flood	24 D	11000 cd	930	88 (min), 91 (nom) Ra8	Warm White	3000 K	2400 Lm	48 Lm/W	70 %
928194405306	MasterColor CDM-R111 Elite 50W/930 GX8.5 40D	Flood	40 D	6000 cd	930	88 (min), 91 (nom) Ra8	Warm White	3000 K	2400 Lm	48 Lm/W	70 %
928195305306	MasterColor CDM-R111 Elite 35W/930 GX8.5 10D	Spot	10 D	36000 cd	930	87 (min), 90 (nom) Ra8	Warm White	3000 K	1450 Lm	37 Lm/W	70 %
928195405306	MasterColor CDM-R111 Elite 35W/930 GX8.5 24D	Narrow Flood	24 D	8500 cd	930	87 (min), 90 (nom) Ra8	Warm White	3000 K	1800 Lm	46 Lm/W	70 %
928195505306	MasterColor CDM-R111 Elite 35W/930 GX8.5 40D	Flood	40 D	4500 cd	930	87 (min), 90 (nom) Ra8	Warm White	3000 K	1800 Lm	46 Lm/W	70 %
928195605306	MasterColor CDM-R111 Elite 70W/930 GX8.5 10D	Spot	10 D	61000 cd	930	89 (min), 92 (nom) Ra8	Warm White	3000 K	2900 Lm	39 Lm/W	70 %
928195705306	MasterColor CDM-R111 Elite 70W/930 GX8.5 24D	Narrow Flood	24 D	16000 cd	930	89 (min), 92 (nom) Ra8	Warm White	3000 K	3700 Lm	50 Lm/W	70 %
928195805306	MasterColor CDM-R111 Elite 70W/930 GX8.5 40D	Flood	40 D	8500 cd	930	89 (min), 92 (nom) Ra8	Warm White	3000 K	3700 Lm	50 Lm/W	70 %

## Light Technical Characteristics (2/2)

Order code	Full product name	Forward Lum Maintenance 2000h	Forward Lum Maintenance 4000h	Forward Lum Maintenance 8000h	Forward Lum Maintenance 12000h	Design Mean Lumens	Chromaticity Coordinate X	Chromaticity Coordinate Y
928194205306	MasterColor CDM-R111 Elite 50W/930 GX8.5 10D	90 %	85 %	80 %	70 %	1550 Lm	0.440 -	0.398 -
928194305306	MasterColor CDM-R111 Elite 50W/930 GX8.5 24D	90 %	85 %	80 %	70 %	2000 Lm	0.440 -	0.398 -
928194405306	MasterColor CDM-R111 Elite 50W/930 GX8.5 40D	90 %	85 %	80 %	70 %	2000 Lm	0.440 -	0.398 -
928195305306	MasterColor CDM-R111 Elite 35W/930 GX8.5 10D	90 %	85 %	80 %	70 %	1200 Lm	0.432 -	0.392 -
928195405306	MasterColor CDM-R111 Elite 35W/930 GX8.5 24D	90 %	85 %	80 %	70 %	1500 Lm	0.432 -	0.392 -
928195505306	MasterColor CDM-R111 Elite 35W/930 GX8.5 40D	90 %	85 %	80 %	70 %	1500 Lm	0.432 -	0.392 -
928195605306	MasterColor CDM-R111 Elite 70W/930 GX8.5 10D	90 %	85 %	80 %	70 %	2400 Lm	0.437 -	0.396 -
928195705306	MasterColor CDM-R111 Elite 70W/930 GX8.5 24D	90 %	85 %	80 %	70 %	3100 Lm	0.437 -	0.396 -
928195805306	MasterColor CDM-R111 Elite 70W/930 GX8.5 40D	90 %	85 %	80 %	70 %	3100 Lm	0.437 -	0.396 -

Light technical

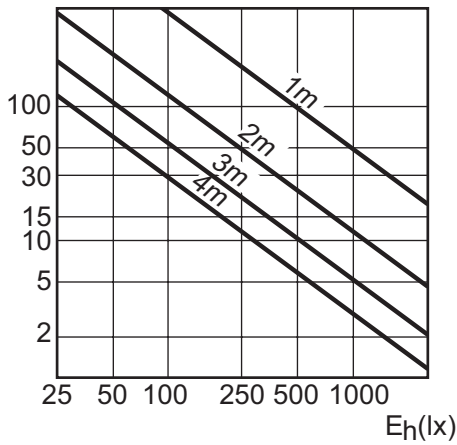

CDM-R111 Elite 50W /930 10D

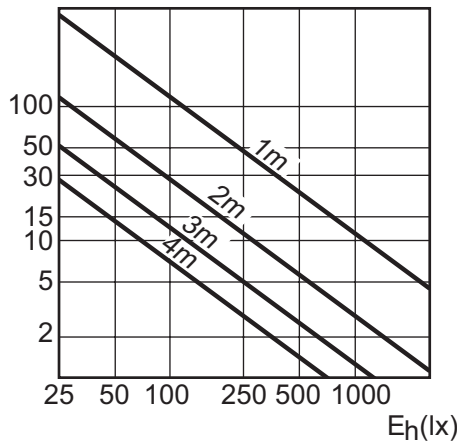

CDM-R111 Elite 50W /930 24D

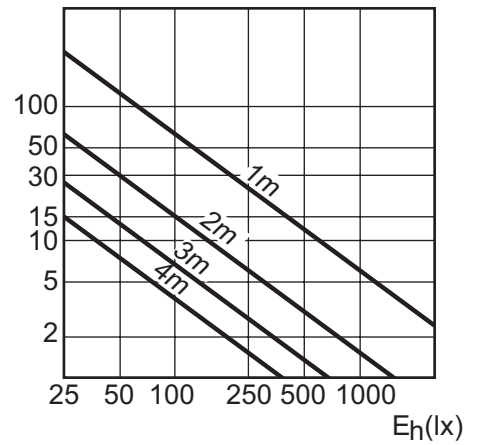

CDM-R111 Elite 50W /930 40D

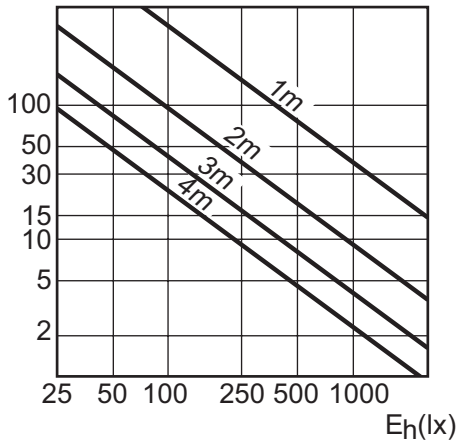

CDM-R111 Elite 35W /930 10D

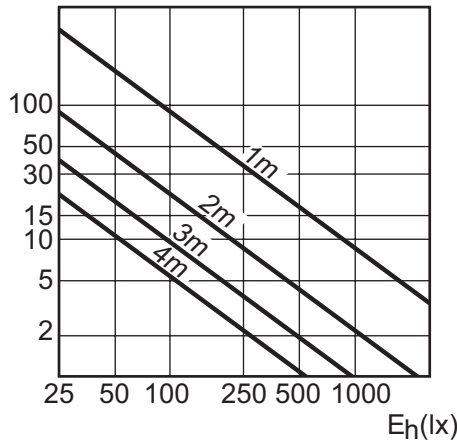

CDM-R111 Elite 35W /930 24D

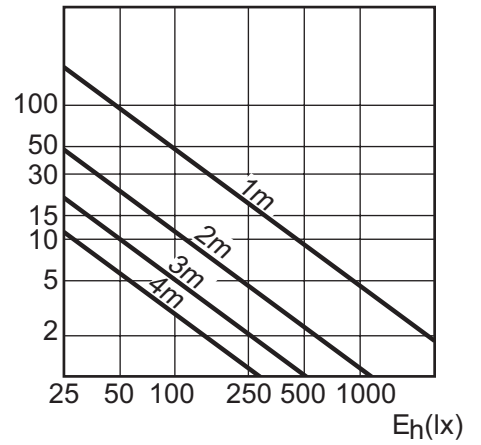

CDM-R111 Elite 35W /930 40D

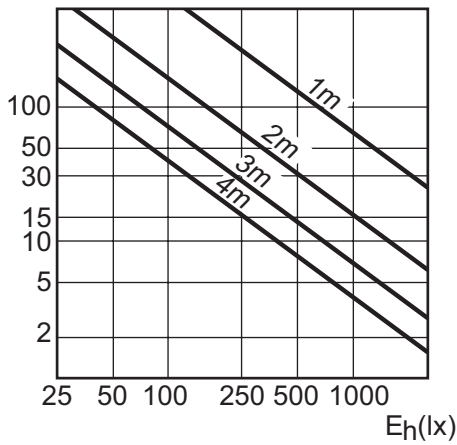

CDM-R111 Elite 70W /930 10D

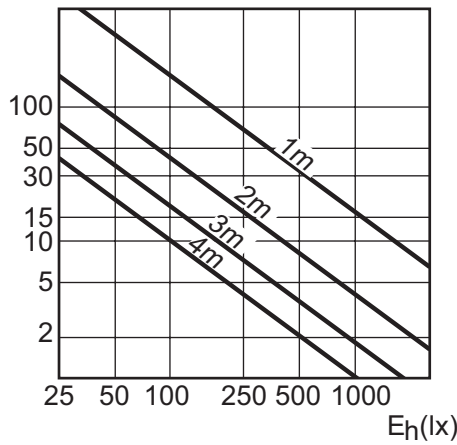

CDM-R111 Elite 70W /930 24D

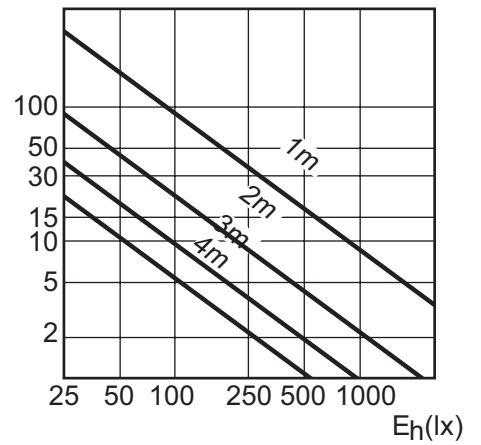

CDM-R111 Elite 70W /930 40D

Light technical

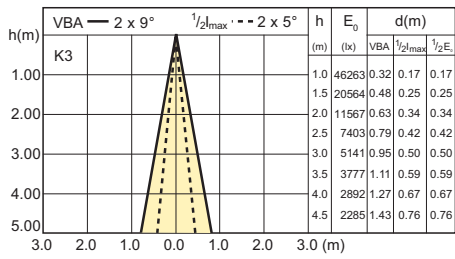

CDM-R111 Elite 50W /930 10D

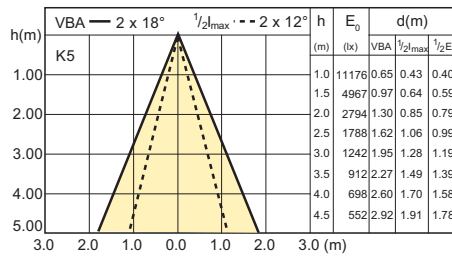

CDM-R111 Elite 50W /930 24D

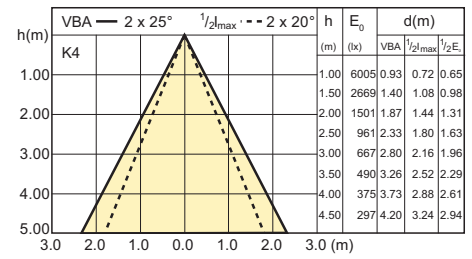

CDM-R111 Elite 50W /930 40D

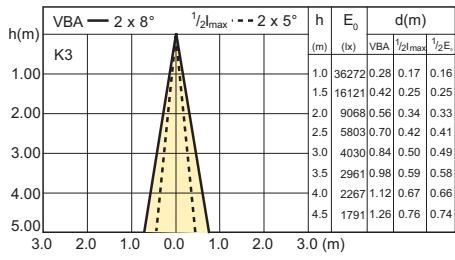

CDM-R111 Elite 35W /930 10D

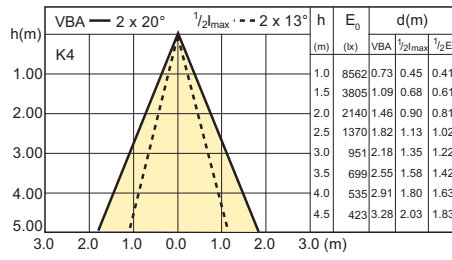

CDM-R111 Elite 35W /930 24D

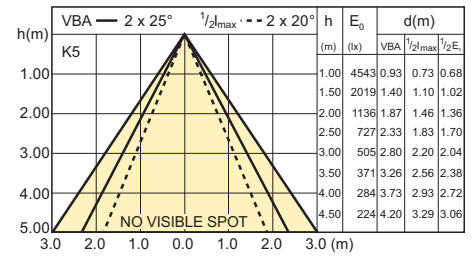

CDM-R111 Elite 35W /930 40D

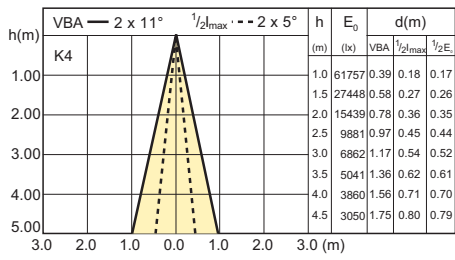

CDM-R111 Elite 70W /930 10D

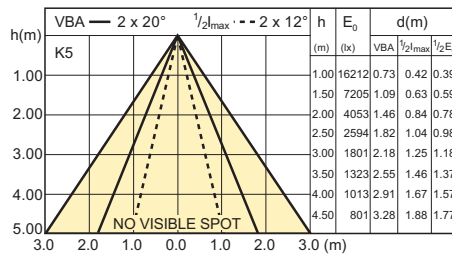

CDM-R111 Elite 70W /930 24D

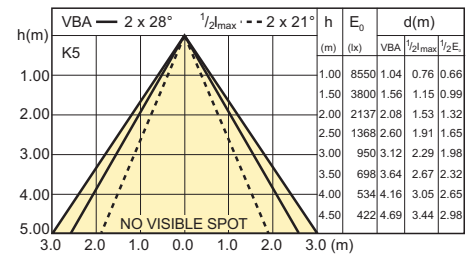

CDM-R111 Elite 70W /930 40D

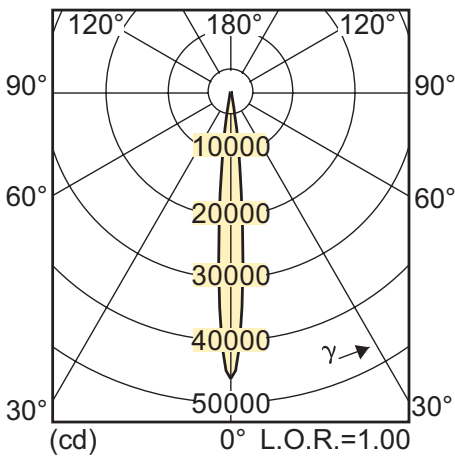

CDM-R111 Elite 50W /930 10D

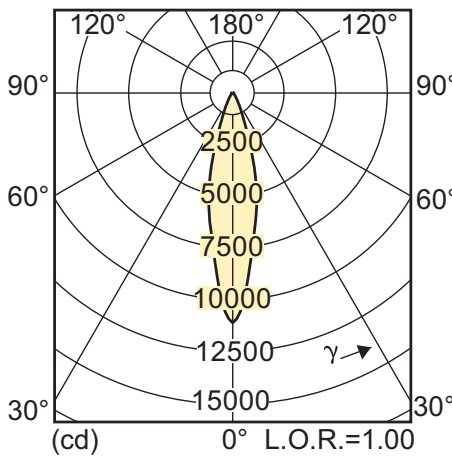

CDM-R111 Elite 50W /930 24D

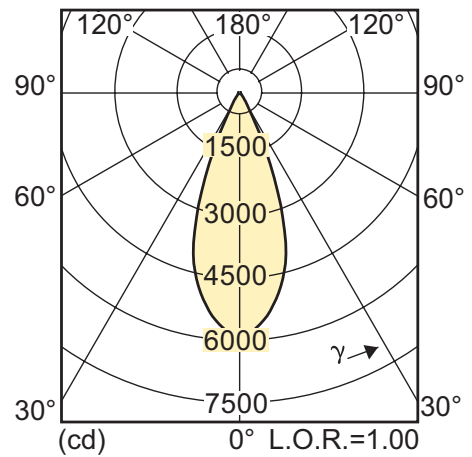

CDM-R111 Elite 50W /930 40D

Light technical

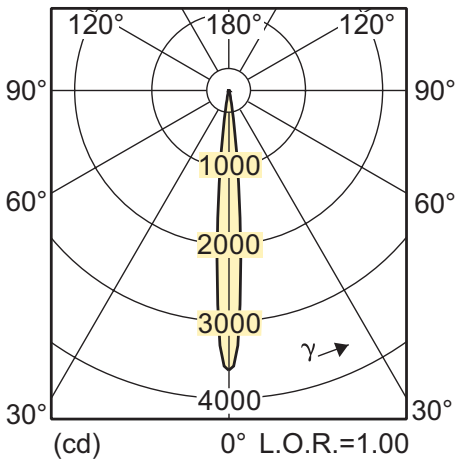

CDM-R111 Elite 35W /930 10D

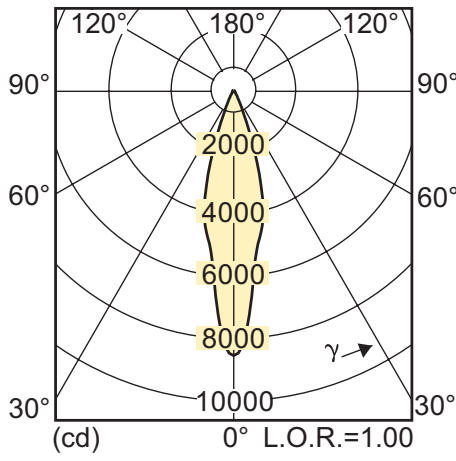

CDM-R111 Elite 35W /930 24D

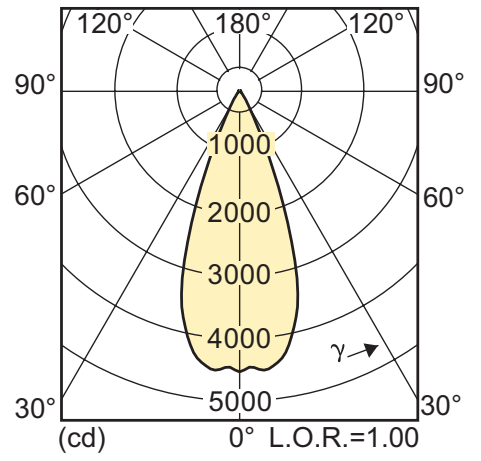

CDM-R111 Elite 35W /930 40D

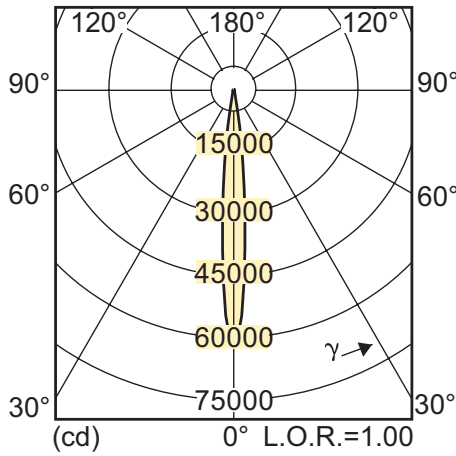

CDM-R111 Elite 70W /930 10D

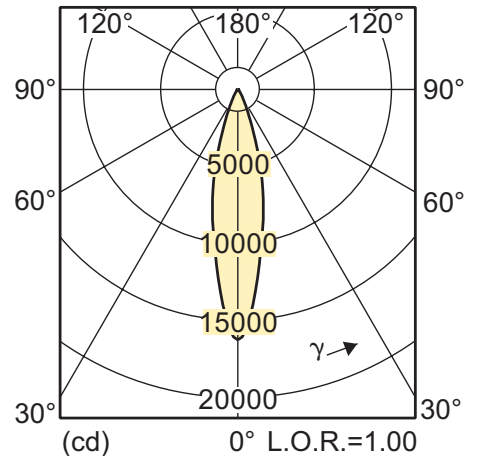

CDM-R111 Elite 70W /930 24D

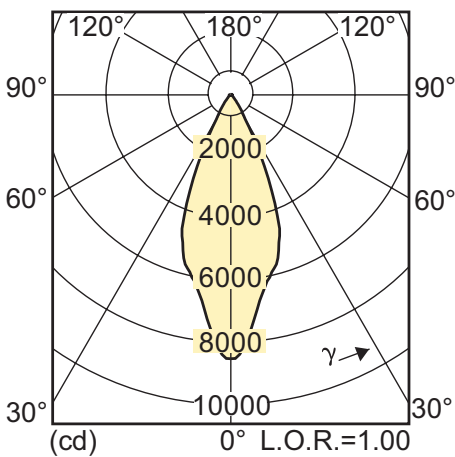

CDM-R111 Elite 70W /930 40D

## Electrical Characteristics

Order code	Full product name	Energy Used	Lamp Wattage EM	Lamp Wattage EM 25°C, Rated	Lamp Wattage EL	Lamp Wattage EL 25°C, Rated	Lamp Voltage	Lamp Current EM	Lamp Current EL	Dimmable	Warm-up Time to 60% Light Outp
928194205306	MasterColor CDM-R111 Elite 50W/930 GX8.5 10D	50 W	W	W	50 W	50.0 W	90 V	A	0.550 A	No	120 s
928194305306	MasterColor CDM-R111 Elite 50W/930 GX8.5 24D	50 W	W	W	50 W	50.0 W	90 V	A	0.550 A	No	120 s
928194405306	MasterColor CDM-R111 Elite 50W/930 GX8.5 40D	50 W	W	W	50 W	50.0 W	90 V	A	0.550 A	No	120 s
928195305306	MasterColor CDM-R111 Elite 35W/930 GX8.5 10D	35 W	35 W	39.0 W	35 W	39.0 W	89 V	0.440 A	0.440 A	No	120 s
928195405306	MasterColor CDM-R111 Elite 35W/930 GX8.5 24D	35 W	35 W	40.0 W	35 W	39.0 W	89 V	0.440 A	0.440 A	No	120 s
928195505306	MasterColor CDM-R111 Elite 35W/930 GX8.5 40D	35 W	35 W	39.0 W	35 W	39.0 W	89 V	0.440 A	0.440 A	No	120 s
928195605306	MasterColor CDM-R111 Elite 70W/930 GX8.5 10D	70 W	W	W	70 W	73.0 W	89 V	A	0.820 A	No	120 s
928195705306	MasterColor CDM-R111 Elite 70W/930 GX8.5 24D	70 W	W	W	70 W	73.0 W	89 V	A	0.820 A	No	120 s
928195805306	MasterColor CDM-R111 Elite 70W/930 GX8.5 40D	70 W	W	W	70 W	73.0 W	89 V	A	0.820 A	No	120 s

## Environmental Characteristics

Order code	Full product name	Energy Efficiency Label (EEL)	Mercury (Hg) Content	Energy consumption kWh/1000h
928194205306	MasterColor CDM-R111 Elite 50W/930 GX8.5 10D	B	6.6 mg	55 kWh
928194305306	MasterColor CDM-R111 Elite 50W/930 GX8.5 24D	A	6.6 mg	55 kWh
928194405306	MasterColor CDM-R111 Elite 50W/930 GX8.5 40D	A	6.6 mg	55 kWh
928195305306	MasterColor CDM-R111 Elite 35W/930 GX8.5 10D	B	4.7 mg	43 kWh
928195405306	MasterColor CDM-R111 Elite 35W/930 GX8.5 24D	A	4.7 mg	43 kWh
928195505306	MasterColor CDM-R111 Elite 35W/930 GX8.5 40D	A	4.7 mg	43 kWh
928195605306	MasterColor CDM-R111 Elite 70W/930 GX8.5 10D	B	6.6 mg	80 kWh

Order code	Full product name	Energy Efficiency Label (EEL)	Mercury (Hg) Content	Energy consumption kWh/1000h
928195705306	MasterColor CDM-R111 Elite 70W/930 GX8.5 24D	A	6.6 mg	80 kWh
928195805306	MasterColor CDM-R111 Elite 70W/930 GX8.5 40D	A	6.6 mg	80 kWh

## Measuring Conditions

Order code	Full product name	Switching cycle
928194205306	MasterColor CDM-R111 Elite 50W/930 GX8.5 10D	1050X
928194305306	MasterColor CDM-R111 Elite 50W/930 GX8.5 24D	1050X
928194405306	MasterColor CDM-R111 Elite 50W/930 GX8.5 40D	1050X
928195305306	MasterColor CDM-R111 Elite 35W/930 GX8.5 10D	1050X
928195405306	MasterColor CDM-R111 Elite 35W/930 GX8.5 24D	1050X
928195505306	MasterColor CDM-R111 Elite 35W/930 GX8.5 40D	1050X
928195605306	MasterColor CDM-R111 Elite 70W/930 GX8.5 10D	1050X
928195705306	MasterColor CDM-R111 Elite 70W/930 GX8.5 24D	1050X
928195805306	MasterColor CDM-R111 Elite 70W/930 GX8.5 40D	1050X





© 2013 Koninklijke Philips N.V. (Royal Philips)  
All rights reserved.

Specifications are subject to change without notice. Trademarks are the property of Koninklijke Philips N.V. (Royal Philips) or their respective owners.

[www.philips.com/lighting](http://www.philips.com/lighting)

2013, August 28  
data subject to change