

## QTi DALI 2X28/54 DIM

QUICKTRONIC INTELLIGENT DALI DIM T5 | ECG dimmable DALI for FL 16 mm



### Areas of application

- Suitable for use in emergency lighting systems as per EN 50172/DIN VDE 0108-100
- Installation in emergency lighting systems according to IEC 61347-2-3, appendix J
- Industry
- Open-plan offices, corridors and storage rooms
- Public buildings
- Sports halls and factories
- Strip lighting
- Shop lighting
- Suitable for luminaires of protection class I

### Product family benefits

- System+ Guarantee available
- Easy integration in luminaire thanks to same dimensions like DALI GI ECG
- TouchDIM function for easy and inexpensive dimming of several ECGs
- Same luminous flux with direct and alternating current
- Dimming of amalgam lamps without flickering or reduced lifespan
- Automatic restart after lamp replacement

### DALI product features

- Control via the DALI interface
- Compliance with the DALI Version-1 and IEC 60929
- Control input protected against overvoltage and polarity reversal (OSRAM ECG)

### Touch DIM and Touch DIM Sensor function

- Manual dimming without controller and with standard switches
- Including memory function (double click) and soft start

## Product datasheet

---

### Product family features

- Corridor function for direct connection of ECG to common motion sensor
- Corridor function with pre-programmed light program
- Touch DIM function for free parameterization of light value and turn on time
- Fit for SMART GRID for feedback of consumed mains power and lamp operating hours
- Fit for emergency function for automatic detection of emergency lighting by ECG
- Very low standby power consumption: < 0.2 W (A1 BAT)
- Lifetime: > 100,000 h (for T = 65 °C at T<sub>c</sub>)
- Very high number of switching cycles: up to 300,000
- Dimming range: 1...100 % (3...100 % with compact fluorescent lamp)
- POWER2LAMP function for optimal matching of ECG power to lamp during lamp lifetime
- Line frequency: 0 Hz, 50...60 Hz, rectified AC

# Product datasheet

## Technical data

### Electrical data

Input voltage AC	198...264 V
Nominal voltage	220...240 V
Mains frequency	50...60 Hz
Input voltage DC	154...276 V
Operating frequency	44...120 kHz
Max. ECG no. on circuit breaker 10 A (B)	8 <sup>1)</sup>
Max. ECG no. on circuit breaker 16 A (B)	13 <sup>1)</sup>
Inrush current	45 A

<sup>1)</sup> Type B

### Light technical data

Starting time	0.6 s <sup>1)</sup>
---------------	---------------------

<sup>1)</sup> Optimized preheat start

### Dimensions & weight

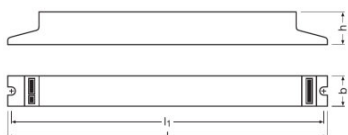

Length	423.0 mm
Width	30.0 mm
Height	21.0 mm
Mounting hole spacing, length	415.0 mm
Product weight	370.00 g
Cable cross-section, output side	0.5...1.5 / 0.5...1.0 mm <sup>2</sup> <sup>1)</sup>
Cable cross-section, input side	0.5...1.5 / 0.5...1.0 mm <sup>2</sup> <sup>1)</sup>

<sup>1)</sup> Solid leads / Flexible

### Temperatures & operating conditions

Ambient temperature range	+10...+50 °C
---------------------------	--------------

## Product datasheet

<b>Permitted rel. humidity during operation</b>	5...85 % <sup>1)</sup>
---	------------------------

<sup>1)</sup> Maximum 56 days/year at 85 %

### Lifespan

<b>ECG lifetime</b>	100000 h <sup>1)</sup>
---------------------	------------------------

<sup>1)</sup> At  $T_{case} = 65^{\circ}\text{C}$  at  $T_{c\text{-point}}$  / 10% failure rate

### Expected Lifetime

Product name	Lamp group				
QTi DALI 2X28/54 DIM	DULUX L 55 W	ECG ambient temperature [ta]	40	50	60
		Temperature at tc-point [°C]	60	70	75
		Lifetime [h]	100000	100000	80000
	HE 28 W	ECG ambient temperature [ta]	40	50	60
		Temperature at tc-point [°C]	50	60	70
		Lifetime [h]	100000	100000	100000
	HO 50 W ES	ECG ambient temperature [ta]	40	50	60
		Temperature at tc-point [°C]	55	65	75
		Lifetime [h]	100000	100000	90000
	HO 54 W	ECG ambient temperature [ta]	40	50	60
		Temperature at tc-point [°C]	55	65	75
		Lifetime [h]	100000	100000	90000
	HO 54 W XT	ECG ambient temperature [ta]	40	50	60
		Temperature at tc-point [°C]	55	65	75
		Lifetime [h]	100000	100000	90000

### Additional product data

<b>Suitable for lamp power (2 lamps)</b>	28...54 W
--	-----------

### Capabilities

<b>Dimming interface</b>	DALI / Touch DIM / Touch DIM Sensor
<b>Dimming range</b>	1...100 % <sup>1)</sup>
<b>Dimmable</b>	Yes
<b>Overheating protection</b>	Power reduction and switch off at $T > 75^{\circ}\text{C}$ at the tc point
<b>Suitable for fixtures with prot. class</b>	I
<b>End of lamp life safety shutdown</b>	EOL T.2
<b>Max. cable length to lamp/LED module</b>	1.0 m / 1.5 m

<sup>1)</sup> Luminous flux

Certificates & standards

Approval marks – approval	VDE / VDE-EMC / EL / EAC / RCM / CCC
Standards	Acc. to EN 61347-2-3/Acc. to EN 60929/Acc. to EN 55015:2006 + A1:2007/Acc. to EN 61000-3-2/Acc. to EN 61547/Acc. to IEC 62386-101:Ed1/Acc. to IEC 62386-102:Ed1
EEL – Energy Label	A1 BAT
Protection class	I
Type of protection	IP20

Logistical data

Commodity code	850410809000
----------------	--------------

Wiring Diagram

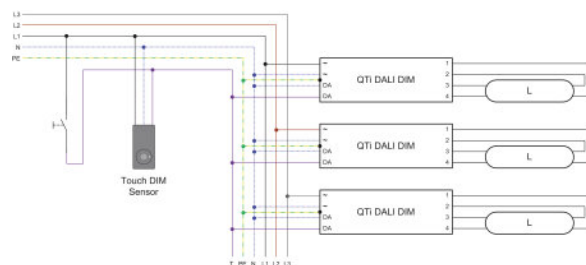
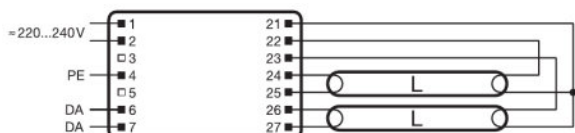

Wiring diagram

Wiring diagram

## Product datasheet

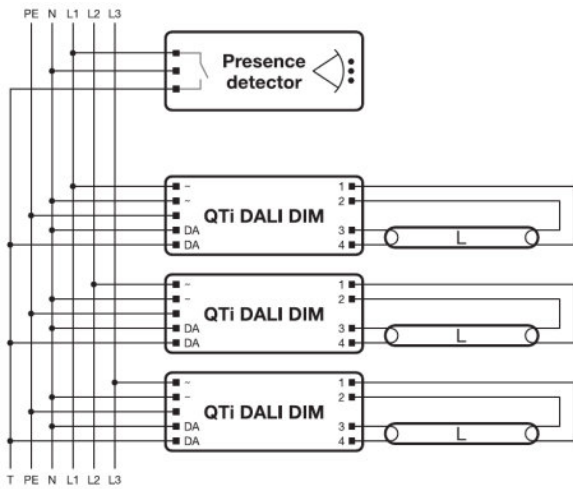



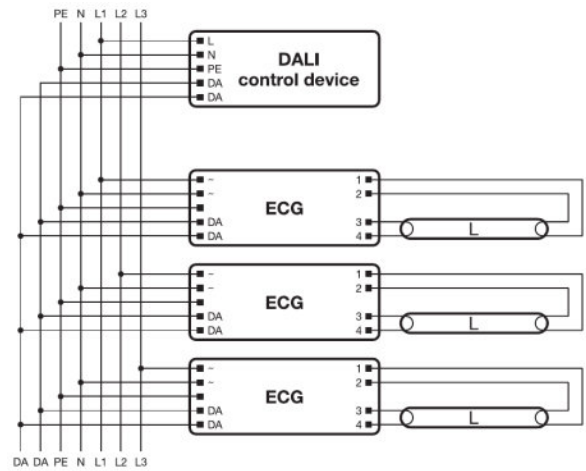







Wiring diagram









Wiring diagram

### Download Data

File	
	Addon Technical Information 502689_Frequent switching Quicktronic
	Addon Technical Information 502785_ECG lifetime - QUICKTRONIC (DALI) DIM
	Product Datasheet 321478_ATI QTİ DALI 2x2854 DIM (G+GB)
	Certificates 335097_INOTEC
	Certificates QTİ DALI VDE 40021252 210920
	Certificates 335135_Manufacturer's declaration &#150; Burning-in of fluorescent lamps
	Certificates 335153_Manufacturer's declaration &#150; Low stand-by
	Certificates 335154_Manufacturer's declaration &#150; EN 55015:2006+A1:2007 (300 MHz)
	Certificates 335169_Manufacturer's declaration &#150; LampECG combinations: Frequent switching
	Certificates 592319_EAC certificate for Quicktronics QT
	Certificates 504208_VDE-EMC-CERTIFICATE QTİ DALI DIM

## Product datasheet

---

	Declarations of conformity 334957_Declaration of conformity
	Installation/Operation notice 334142_Technical guide - ECGs for T5-lamps
	Operating instructions 592411_EAC QT <sub>i</sub> T5 DALI DIM
	CAD data 3-dim 313428_423x30x21 1881282
	CAD data 3-dim 313430_423x30x21 1881282
	CAD data 3-dim 313444_423x30x21 1881282
	CAD data PDF 313416_423x30x21 1881282

---

### Logistical Data

Product code	Product description	Packaging unit (Pieces/Unit)	Dimensions (length x width x height)	Volume	Gross weight
4050300870502	QT <sub>i</sub> DALI 2X28/54 DIM	Shipping carton box 20	455 mm x 98 mm x 163 mm	7.27 dm <sup>3</sup>	7640.00 g

---

The mentioned product code describes the smallest quantity unit which can be ordered. One shipping unit can contain one or more single products. When placing an order, for the quantity please enter single or multiples of a shipping unit.

### References / Links

For more information on the system guarantee and the terms and conditions of the guarantee visit

▶ [www.osram.com/system-guarantee](http://www.osram.com/system-guarantee)

### Disclaimer

Subject to change without notice. Errors and omission excepted. Always make sure to use the most recent release.

## QTi DALI 2X28/54 DIM

QUICKTRONIC INTELLIGENT DALI DIM T5 | ECG dimmable DALI for FL 16 mm

Product name	Lamp group	Nominal current	Nominal wattage + Power loss	Luminous flux at 35 °C	Number of lighting outlets
QTi DALI 2X28/54 DIM	DULUX L 26 W HE	0.27 A	60.20 W	2700 lm	2
	DULUX L 28 W HE	0.27 A	60.20 W	2700 lm	2
	DULUX L 55 W	0.51 A	115.00 W	4800 lm	2
	FC 55 W	0.51 A	115.00 W	4450 lm	2
	HE 28 W	0.27 A	60.20 W	2600 lm	2
	HO 50 W ES	0.51 A	115.00 W	4800 lm	2
	HO 54 W	0.51 A	115.00 W	4450 lm	2
	HO 54 W XT	0.51 A	115.00 W	4850 lm	2