

## QT-M 2X26...42 S

QUICKTRONIC MULTIWATT | ECG for CFL



### Areas of application

- Emergency lighting systems acc. to EN 50172 / DIN VDE 0108-100
- Public buildings
- Sports halls and factories
- Suitable for luminaires of protection class I

### Product benefits

- Long lamp life
- No adverse effect from frequent on/off switching
- Automatic restart after lamp replacement
- Perfect lamp start for applications with motion sensors
- Separate installations thanks to optional cable clamp for K2 and K3 casings
- VDE/VDE EMC certified system

### Product features

- Supply voltage: 220...240 V
- Line voltage: 198...264 V
- Line frequency: 0 Hz | 50 Hz | 60 Hz
- Lamp start with optimum filament preheating
- Energy Efficiency Index EEI: A2
- Automatic shutdown of defective lamps and at end of life (EoL T.2)
- Lamp operation: to EN 60929
- Safety: to EN 61347-2-3

Technical data

Electrical data

Input voltage AC	198...264 V
Line current	0.39 A
Nominal voltage	220...240 V
Mains frequency	50...60 Hz
Input voltage DC	176...254 V <sup>1)</sup>
Operating frequency	45 kHz <sup>2)</sup>
Max. ECG no. on circuit breaker 10 A (B)	8 <sup>3)</sup>
Max. ECG no. on circuit breaker 16 A (B)	13 <sup>3)</sup>
Inrush current	28 A

<sup>1)</sup> Minimum voltage for lamp ignition: 198 V

<sup>2)</sup> Approximately

<sup>3)</sup> Type B

Light technical data

Starting time	1.0 s
---------------	-------

Dimensions & weight

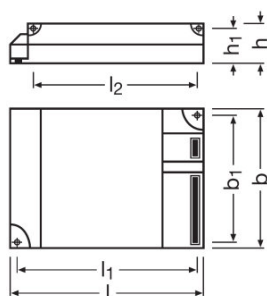

Length	123.0 mm
Width	79.0 mm
Height	33.0 mm
Mounting hole spacing, length	111.0 mm
Product weight	280.00 g
Cable cross-section, output side	0.5...1.5 mm <sup>2</sup>
Cable cross-section, input side	0.5...1.5 mm <sup>2</sup>

Temperatures & operating conditions

## Product datasheet

Ambient temperature range	-20...+50 °C
Permitted rel. humidity during operation	5...85 %

### Lifespan

ECG lifetime	50000 h <sup>1)</sup>
--------------	-----------------------

<sup>1)</sup> At  $T_{case} = 75^{\circ}C$  at  $T_c$  point / 10% failure rate

### Capabilities

Suitable for fixtures with prot. class	I / II
End of lamp life safety shutdown	EOL T.2

### Certificates & standards

Approval marks – approval	VDE / VDE-EMC / ENEC 10 / GOST / RCM
EEI – Energy Label	A2
Standards	Acc. to EN 61347-2-3/Acc. to EN 60929/Acc. to EN 55015:2006 + A1:2007/Acc. to EN 61000-3-2/Acc. to EN 61547
Protection class	I
Type of protection	IP20

### Wiring Diagram

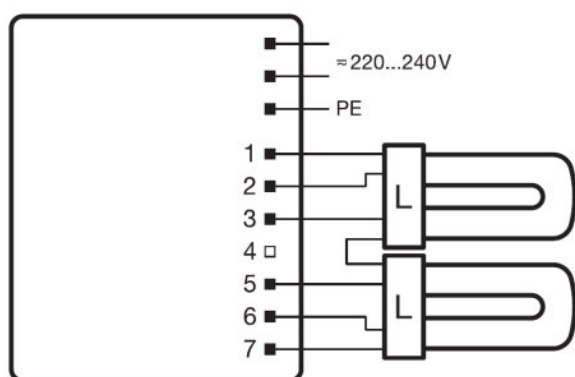



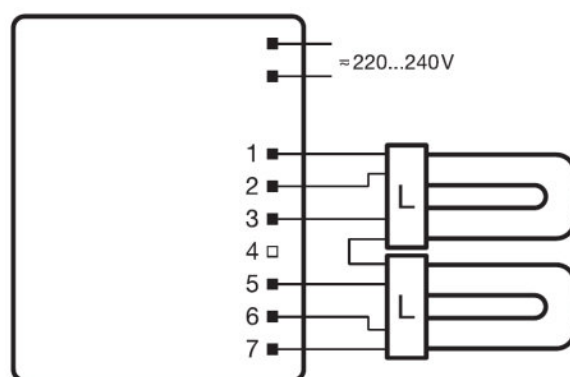







Wiring diagram



Wiring diagram

## Product datasheet

### Download Data

File	
	Certificates EMC-Marks approval QT-M
	Certificates ENEC-Marks approval QT-M
	Certificates CEAG requirements Compatibility to modules of manufacturers for emergency lighti
	Certificates Manufacturer's declaration LampECG combinations: Frequent switching
	Certificates VDE-EMC-Certificate QT-M
	Declarations of conformity Declaration of conformity QT-M
	Operating instructions EAC QTP-M
	CAD data 3-dim 123x79x33 9900044
	CAD data 3-dim 123x79x33 9900044
	CAD data 3-dim 123x79x33 9900044
	CAD data PDF 123x79x33 9900044

### Logistical Data

Product code	Product description	Packaging unit (Pieces/Unit)	Dimensions (length x width x height)	Volume	Gross weight
4008321110022	QT-M 2X26...42 S	Shipping carton box 20	412 mm x 101 mm x 260 mm	10.82 dm <sup>3</sup>	5865.00 g

The mentioned product code describes the smallest quantity unit which can be ordered. One shipping unit can contain one or more single products. When placing an order, for the quantity please enter single or multiples of a shipping unit.

### Disclaimer

Subject to change without notice. Errors and omission excepted. Always make sure to use the most recent release.

## QT-M 2X26...42 S

## QUICKTRONIC MULTIWATT | ECG for CFL

Product name	Lamp group	Nominal current	Nominal wattage + Power loss	Luminous flux at 25 °C	Number of lighting outlets	Luminous flux at 35 °C
QT-M 2X26...42 S	DULUX D/E 26 W	0.23 A	54.00 W	2*1800 lm	2	
	DULUX F 24 W	0.23 A	54.00 W		2	1700 lm
	DULUX F 36 W	0.30 A	70.00 W		2	2700 lm
	DULUX L 24 W	0.23 A	54.00 W		2	1750 lm
	DULUX L 24 W XT	0.23 A	54.00 W		2	1750 lm
	DULUX L 36 W	0.30 A	70.00 W		2	2800 lm
	DULUX L 36 W XT	0.30 A	70.00 W		2	2800 lm
	DULUX T/E 26 W	0.23 A	54.00 W	1800 lm	2	
	DULUX T/E 26 W CONSTANT	0.23 A	54.00 W	1800 lm	2	
	DULUX T/E 32 W	0.30 A	70.00 W	2400 lm	2	
	DULUX T/E 32 W CONSTANT	0.30 A	70.00 W	2400 lm	2	
	DULUX T/E 32 W XT	0.30 A	70.00 W	2400 lm	2	
	DULUX T/E 42 W	0.39 A	92.00 W	3200 lm	2	
	DULUX T/E 42 W CONSTANT	0.39 A	92.00 W	3200 lm	2	
	FC 22 W	0.36 A	54.00 W	1600 lm	2	1600 lm
	FC 40 W	0.36 A	88.00 W		2	3200 lm
	HO 24 W	0.23 A	54.00 W		2	1750 lm
	HO 24 W CONSTANT	0.23 A	54.00 W		2	1900 lm

## Product datasheet

Product name	Lamp group	Nominal current	Nominal wattage + Power loss	Luminous flux at 25 °C	Number of lighting outlets	Luminous flux at 35 °C
	L 36 W	0.30 A	70.00 W		2	3200 lm