

2X18...42 DIM

QUICKTRONIC INTELLIGENT DIM CFL | ECG dimmable 1...10 V for CFL



Areas of application

- Suitable for use in emergency lighting systems as per EN 50172/DIN VDE 0108-100
- Industry
- Open-plan offices, corridors and storage rooms
- Public buildings
- Suitable for luminaires of protection class I

Product family benefits

- Same luminous flux with direct and alternating current
- Perfect lamp start for applications with motion sensors
- Dimming of amalgam lamps without flickering or reduced lifespan
- Very high efficiency thanks to cut-off technology
- Automatic restart after lamp replacement
- ECGs comply with MINERGIE standard due to very low standby consumption
- Configurable emergency power characteristics
- Control via the 1...10 V interface

Product datasheet

Product family features

- Control via 1...10 V interface
- Supply voltage: 220...240 V
- Line frequency: 0 Hz | 50 Hz | 60 Hz
- Line voltage: 198...264 V
- Dimming range: 3...100 % luminous flux
- Lamp start: within 0.6 s
- Lifetime: > 100,000 h (for T = 65 °C at T_c)
- Automatic shutdown of defective lamps and at end of life (EoL T.2)
- Energy Efficiency Index EEI: A1 BAT
- Overtemperature protection: Thermal management at high t_c temperatures
- Safety: to EN 61347-2-3
- Lamp operation: to EN 60929
- RI suppression: to EN 55015:2006+A1:2007+A2:2009/CISPR 15
- Line harmonics according to EN 61000-3-2
- Immunity according to EN 61547

Product datasheet

Technical data

Electrical data

Nominal voltage	220...240 V
Mains frequency	50...60 Hz
Input voltage DC	154...276 V
Operating frequency	42...140 kHz
Max. ECG no. on circuit breaker 10 A (B)	8 ¹⁾
Max. ECG no. on circuit breaker 16 A (B)	13 ¹⁾
Inrush current	45 A

¹⁾ Type B

Light technical data

Starting time	0.6 s ¹⁾
---------------	---------------------

¹⁾ Optimized preheat start

Dimensions & weight

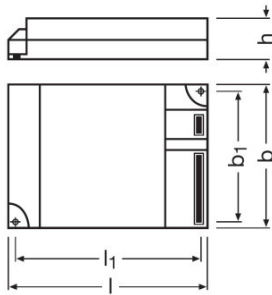

Length	123.0 mm
Width	79.0 mm
Height	33.0 mm
Mounting hole spacing, length	111.0 mm
Product weight	250.00 g

Temperatures & operating conditions

Ambient temperature range	-10...+50 °C
Permitted rel. humidity during operation	5...85 % ¹⁾

¹⁾ Maximum 56 days/year at 85 %

Lifespan

Product datasheet

ECG lifetime	100000 h ¹⁾
---------------------	------------------------

¹⁾ At $T_{case} = 65^{\circ}C$ at T_c point / 10% failure rate

Additional product data

Product remark	Optional cable clamp, see chapter ECG mountings - cable clamp
Suitable for lamp power (2 lamps)	18...42 W

Capabilities

Dimming interface	1...10 V
Dimming range	3...100 %
Dimmable	Yes
Suitable for fixtures with prot. class	I
End of lamp life safety shutdown	EOL T.2
Max. cable length to lamp/LED module	0.5 m

Certificates & standards

Approval marks – approval	VDE / VDE-EMC / EL / EAC / RCM / CCC
Standards	Acc. to EN 61347-2-3/Acc. to EN 60929/Acc. to EN 55015:2006 + A1:2007/Acc. to EN 61000-3-2/Acc. to EN 61547
EEL – Energy Label	A1 BAT
Protection class	I
Type of protection	IP20

Logistical data





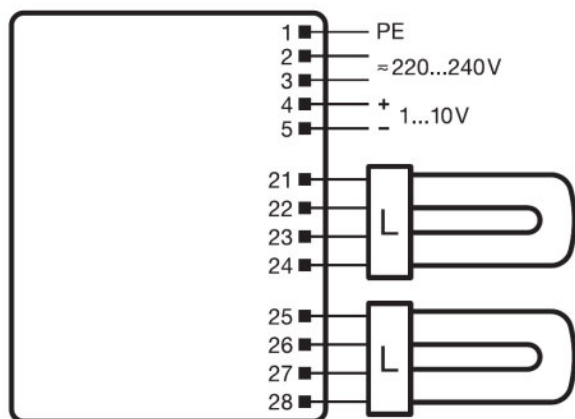





Commodity code	850410809000
-----------------------	--------------

Wiring Diagram



Wiring diagram

Download Data

File	
	Addon Technical Information 502689_Frequent switching Quicktronic
	Addon Technical Information 502785_ECG lifetime - QUICKTRONIC (DALI) DIM
	Certificates 334953_EMC-Marks approval
	Certificates 335097_INOTEC
	Certificates QTI DALI VDE 40021252 210920
	Certificates 335169_Manufacturer's declaration – LampECG combinations: Frequent switching
	Certificates 504208_VDE-EMC-CERTIFICATE QTI DALI DIM
	Declarations of conformity 334771_Declaration of conformity
	Declarations of conformity 334957_Declaration of conformity
	Operating instructions 597739_EAC QTi TE DIM

Product datasheet

	CAD data 3-dim 321654_QTi-TE 2x18-42 DIM
	CAD data 3-dim 321658_QTi-TE 2x18-42 DIM
	CAD data 3-dim 321660_QTi-TE 2x18-42 DIM
	CAD data PDF 321659_QTi-TE 2x18-42 DIM

Logistical Data

Product code	Product description	Packaging unit (Pieces/Unit)	Dimensions (length x width x height)	Volume	Gross weight
4008321060846	2X18...42 DIM	Shipping carton box 20	423 mm x 79 mm x 257 mm	8.59 dm ³	4975.17 g

The mentioned product code describes the smallest quantity unit which can be ordered. One shipping unit can contain one or more single products. When placing an order, for the quantity please enter single or multiples of a shipping unit.

Disclaimer

Subject to change without notice. Errors and omission excepted. Always make sure to use the most recent release.

2X18...42 DIM

QUICKTRONIC INTELLIGENT DIM CFL | ECG dimmable 1...10 V for CFL

Product name	Lamp group	Nominal current	Nominal wattage + Power loss	Luminous flux at 25 °C	Number of lighting outlets	Luminous flux at 35 °C
2X18...42 DIM	DULUX D/E 18 W	0.17 A	38.00 W	2*1200 lm	2	
	DULUX D/E 26 W	0.25 A	56.00 W	2*1800 lm	2	
	DULUX T/E 18 W	0.17 A	38.00 W	1200 lm	2	
	DULUX T/E 26 W	0.25 A	56.00 W	1800 lm	2	
	DULUX T/E 26 W CONSTANT	0.25 A	56.00 W	1800 lm	2	
	DULUX T/E 32 W	0.30 A	69.00 W	2400 lm	2	
	DULUX T/E 32 W CONSTANT	0.30 A	69.00 W	2400 lm	2	
	DULUX T/E 42 W	0.39 A	90.00 W	3200 lm	2	
	DULUX T/E 42 W CONSTANT	0.39 A	90.00 W	3200 lm	2	
	FC 22 W	0.22 A	51.00 W		2	1750 lm
FC 40 W	0.38 A	87.00 W		2	3200 lm	