

USHIO

CERAMIC XENON LAMPS

VAC CERAMIC XENON SERIES



Made in U.S.A.

VAC CERAMIC XENON LAMPS

USHIO America, a respected leader in specialty lighting, brings you the latest advancement in lamp technology - our new "VAC" Ceramic Xenon lamps.

Patent pending design and construction improves consistency and guarantees extraordinary quality for every lamp.

We build to exacting specifications in our U.S. manufacturing facility and hold the new "VAC" Ceramic Xenon lamps to rigorous quality standards.

USHIO "VAC" lamps exceed most requirements in critical applications that demand stable, consistent and long lasting light in surgical, scientific and analytical settings.

APPLICATIONS

- Surgical
- Bio-Medical
- Borescopy
- Microscope
- Analytical
- Fiber Optic Illumination
- Video/Data Projection
- Machine Vision
- Infrared & Visible Searchlights

FEATURES & BENEFITS

- New patent pending design ensures high arc stability and long life.
- Advanced tooling and optical design improves lumen maintenance and arc stability.
- Leading technology, manufacturing and quality processes enable unmatched performance, consistency and reliability - lamp to lamp.
- Strong, 700 hour, non-prorated warranty supports our unparalleled quality.

Distributed by:



CHARACTERISTICS & SPECIFICATIONS

VAC175-F-C VAC300-F-C5

PHYSICAL/MECHANICAL SPECIFICATIONS	VAC175-F-C	VAC300-F-C5
Overall Length	1.643in./41.73mm	1.643in./41.73mm
Diameter	1.297in./32.94mm	1.297in./32.94mm
Window Diameter	1.046in./26.57mm	1.046in./26.57mm
Reflector Geometry	Parabolic	Parabolic
Max. Body Temp. (C°)	150	150

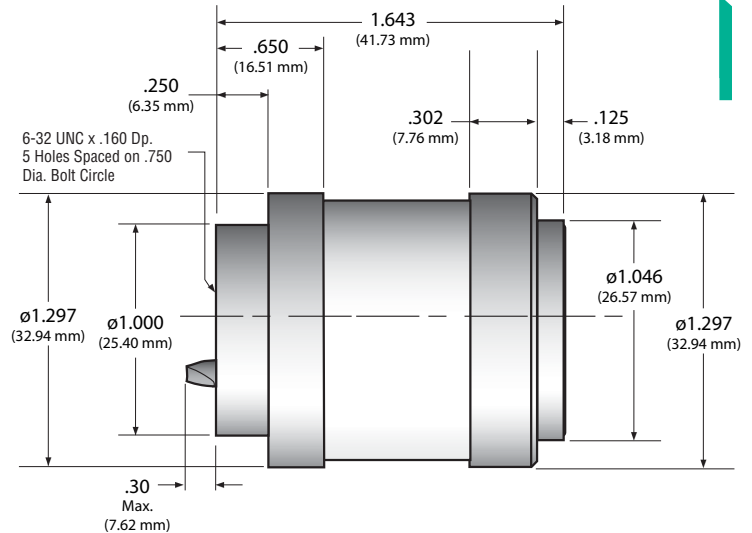

PRODUCT DESCRIPTION USHIO ORDERING CODE	VAC175-F-C 5001603	VAC300-F-C5 5001543
ELECTRICAL SPECIFICATIONS		
Power (Watts)	175W	300W
Power Range (Watts)	150-200W	175-350W
Current (A)	14A	22A
Current Range (A)	12-16A	13-24A
Voltage (V)	12.5V	14V
Voltage Range (V)	11.0-14.0V	11.5-15.5V
Minimum Ignition Voltage at Lamp (kV)	25	25
PHOTOMETRIC SPECIFICATIONS+		
ALL VALUES ARE NOMINAL+		
Radiant Output (Watts)	25	50
Visible Output (Lumens)	2500	6000
UV Output <390nm (Watts)	1.1	2.5
IR Output >770nm (Watts)	16.2	30
Color Temperature (K°)	5600	5600
FOCUSED OUTPUT F/1.0 LENS		
6 MM Aperture (Lumens/Watt)	1600/15.0	3300/29.0
3 MM Aperture (Lumens/Watt)	900/8.0	2200/19.0
Beam Angle at 10% Beam Height	10°	10°
Typical Beam Instability	4%	4%
Typical Life (Hours)*	1,000	1,200
Warranted Life Non-Prorated (Hours)*	700	700
Package Qty	1	1

*Average rated life hours are based on 50% lumen depreciation from initial output as measured through a 6mm aperture.



PERFORMANCE COMPARISON DATA

USHIO's NEW VAC CERAMIC XENON LAMPS

Give More Light and Superior Lumen Maintenance Over Life!

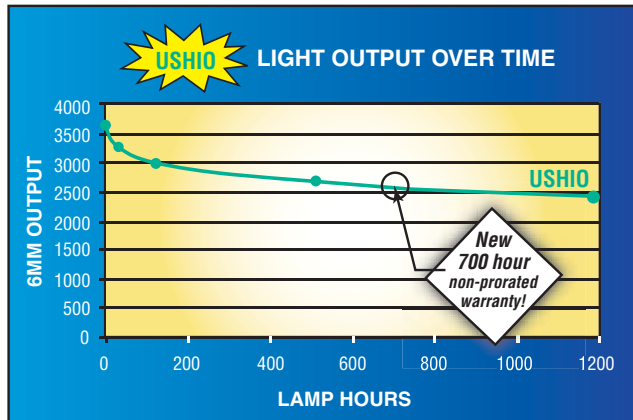

Key developments in lamp design features and technological refinements by industry leading engineers have created a ceramic xenon lamp that starts with *more light output and outlasts all the others!***

**Represents average values measured in lab conditions. All lamps measured under same conditions. Lamps' duty cycle of 1 hour 45 minutes ON and 15 minutes OFF with 32 dBA fan.

USHIO's NEW VAC CERAMIC XENON LAMPS

Have Unrivaled Built-In Quality, Consistent Output, and Performance – *EVERYTIME!*

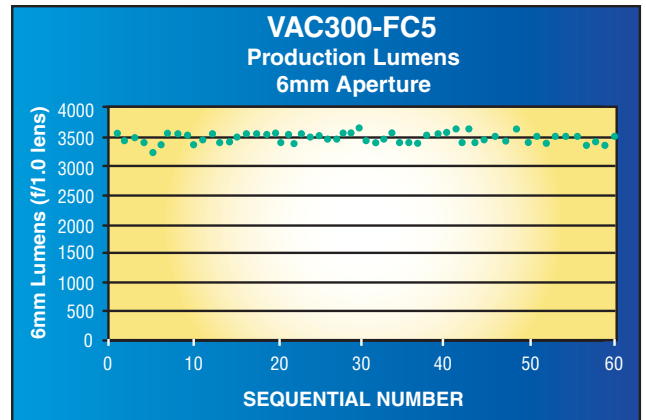

New advanced tooling designs and manufacturing processes reliably ensure your application has the best performing ceramic xenon lamp on the market.

THE NEW USHIO AMERICA VAC LAMPS COME BACKED WITH A NON-PRORATED 700 HOUR WARRANTY. Δ

Confidence in our unmatched quality enables us to give our customers the product they need with extraordinary support. A 40% increase to our standard non-prorated warranty shows the USHIO America commitment to you and your customers!

Δ Contact your Regional Sales Manager or Customer Service Representative for return authorization. Laboratory evaluation and warranty disposition at the sole discretion of USHIO America, Inc., Cypress, CA.

ELECTRODE DESIGN IS THERMALLY MODELED FOR
OPTIMUM LIFE/STABILITY - LESS FLICKER

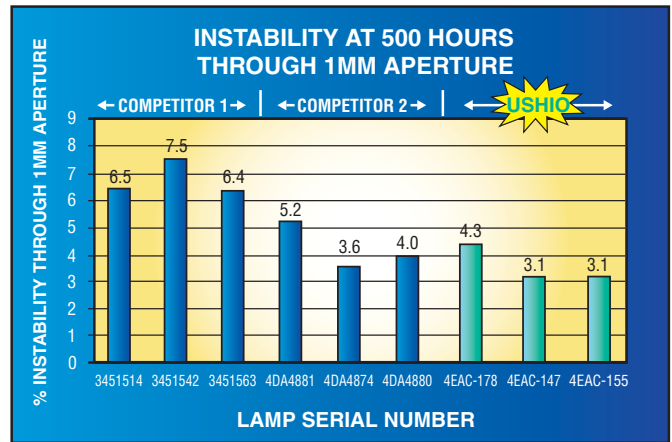
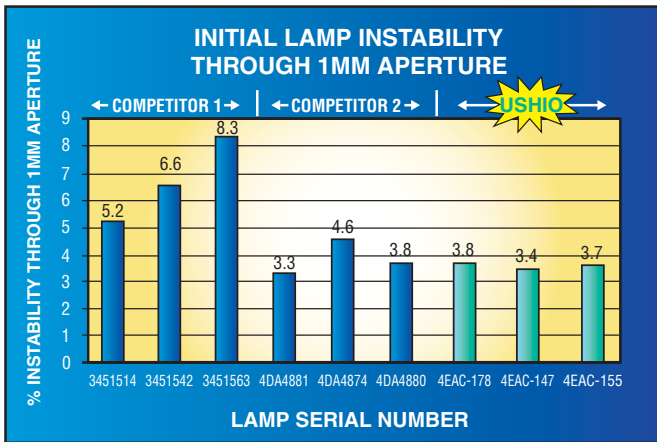

SPECTRAL DISTRIBUTION CHART

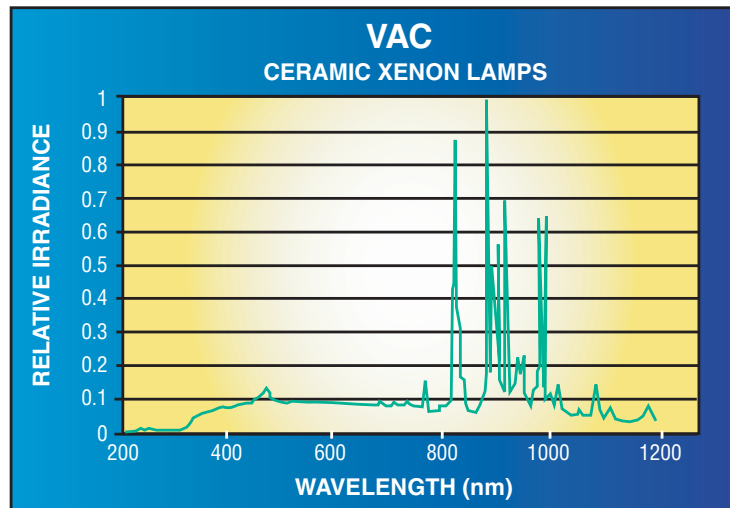

- Observe correct polarity and install the lamp accordingly. Running the lamp with reversed polarity will damage the lamp and void the warranty.
- Do not exceed rated current.
- Lamp should be operated in the horizontal position. Operating the lamp within 45° of vertical with the window up can cause thermal stress on the window and possible failure.
- Lamp operating temperature should not exceed 150° C any time throughout lamp life. Use heatsinks, thermally conductive grease, and forced air cooling to maintain proper operating temperature. A thin layer of thermal grease is required on ALL lamp-to-heatsink mating surfaces.
- Window should be free from grease, fingerprints, and other oils and contaminants to avoid stresses during operation. Use alcohol wipes to clean window as necessary.
- Remove the vinyl tubing from the filling tip before installing the lamp.



Thermal heat transfer paste is necessary on the metal surfaces shown as a means of reducing thermal contact resistance between the lamp and heatsink. This results in decreased lamp operating temperature and improved lamp life. The thermal paste compound should be applied uniformly with a thickness no greater than .005" (.13mm).

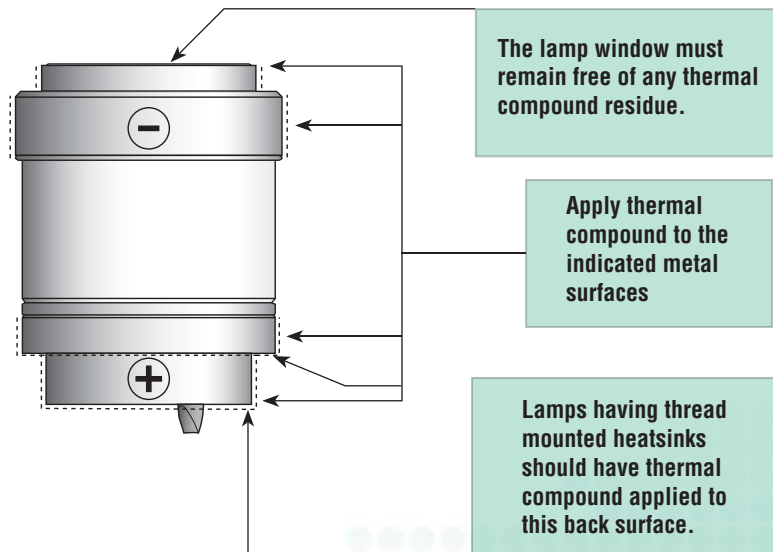

Ceramic Xenon lamps are under high pressure and emit high levels of radiation. Proper handling procedures and safety precautions must be utilized to assure the safety of the user of this product. Only operate this lamp within recommended operating specifications as detailed in our product data sheets.

Safety Hazards – Following these guidelines will help assure user safety:

Explosion: These lamps are under high pressure. Use of face shields or safety glasses during handling is recommended. Avoid applying excessive shock or stress to the lamp during handling.

High Voltage: The ignition voltage presents a high-voltage hazard. Do not touch the lamp during operation. The input power must be disconnected prior to attempting to service the lamp to avoid the risk of electrical shock.

UV, Visible, and IR Radiation: These lamps emit high levels of radiation that can cause severe skin burns and permanent eye damage. Avoid direct exposure to the emitted or reflected beam.

Ozone Emissions: Some lamps emit ultraviolet radiation that can generate ozone. Assure adequate filtration or ventilation during operation to avoid ozone accumulation which can create a respiratory hazard.

Thermal Hazards: These lamps can get very hot during and after operation—up to several hundred degrees centigrade. To avoid potential for serious burns, do not touch lamp during operation, or after, until lamp has adequately cooled.

Disposal: It is recommended that the lamp's internal pressure is relieved prior to disposal. This is accomplished by squeezing the tip-off with pliers until the gas escapes. Pressurized lamps should not be incinerated, but disposed of in a landfill.

For more information on the safe operation of your USHIO lighting products, feel free to contact us at 800.838.7446, or email us at info@ushio.com

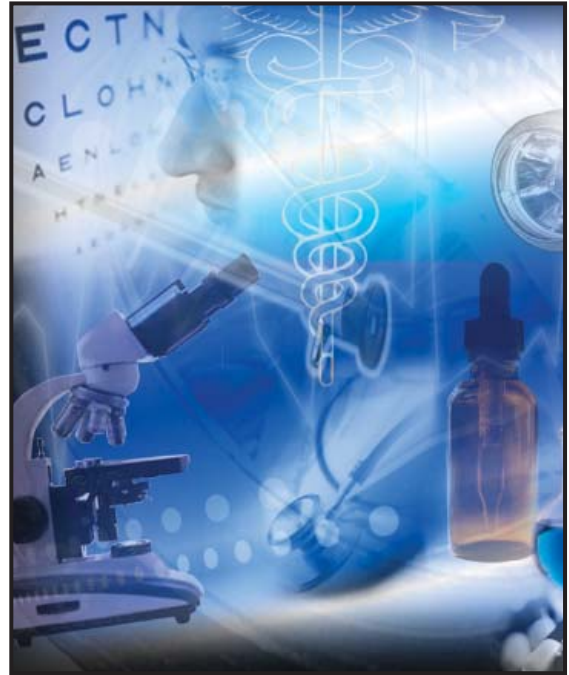

USHIO AMERICA, INC.

5440 Cerritos Ave.
Cypress, CA 90630

714.236.8600
fax 714.229.3181

**National Customer Service Center
Continental U.S.
6:30AM - 5:00PM PST**

**Toll-Free 800-838-7446
24 Hour Fax 800.776-3641**

**USHIO Canada, Inc.
2730 Brighton Road
Oakville, Ontario Canada L6H 5T4
905.829.3338**

**Toll-Free 877.902.0722
Fax 905.829.5343**

FORM NO. S-VAC/R-0112: "VAC" product specifications and/or descriptions are subject to change from time to time without prior notification. Although information contained in these materials are generally considered reliable to the fullest extent permitted by applicable law, USHIO America, Inc. disclaims all liability for any inaccuracy in such information.

Scan with a smartphone
to view this product online.

