



Reptistar T8

FEATURES

- Promotes vitamin D3 production which aids good health, growth and the general well-being of reptiles in terrariums through a high content of UVB (5% and 10%) and UVA (up to 30%)
- This full spectrum (6500 K) lamp improves the natural appearance of reptiles
- Shows reptiles in their true colours

APPLICATIONS

- For the artificial lighting of reptiles in terrariums

DIRECTIONS FOR USE

- This lamp emits UV-radiation. Avoid exposure to skin and eyes

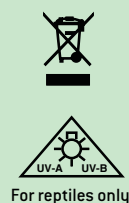
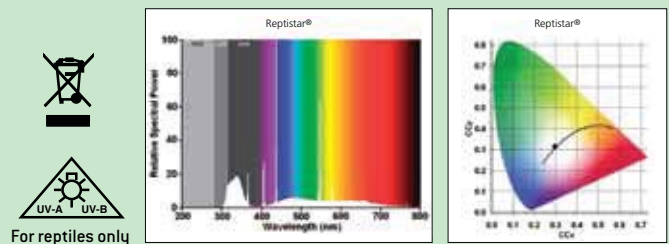
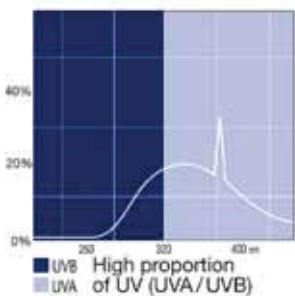
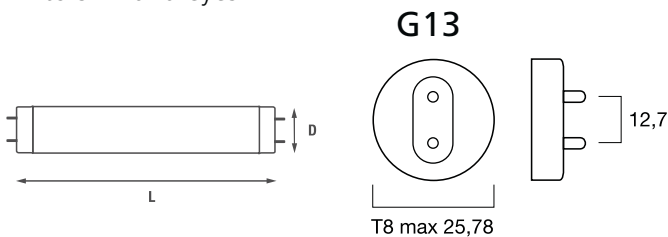

Code	Item description	Dimensions (mm)		Diameter	Watt W	Colour	Cap	Light output lm	Ordering Quantity
		L	D						
0000731	F15W/Reptistar UV-B 5%	438	26	T8	15	UV-B 5%	G13	300	10
0000732	F18W/Reptistar UV-B 5%	590	26	T8	18	UV-B 5%	G13	450	10
0000733	F30W/Reptistar UV-B 5%	895	26	T8	30	UV-B 5%	G13	700	10
0000734	F36W/Reptistar UV-B 5%	1200	26	T8	36	UV-B 5%	G13	1000	10
0000741	F15W/Reptistar UV-B 10%	438	26	T8	15	UV-B 10%	G13	300	10
0000742	F18W/Reptistar UV-B 10%	590	26	T8	18	UV-B 10%	G13	450	10
0000743	F30W/Reptistar UV-B 10%	895	26	T8	30	UV-B 10%	G13	700	10
0000744	F36W/Reptistar UV-B 10%	1200	26	T8	36	UV-B 10%	G13	1000	10

Packaging Note: The sleeve pictured is for retail sales.

Reptistar MiniLynx



FEATURES

- High UV-B radiation. UV-B peak intensity @ 100mm: 160 $\mu\text{W}/\text{cm}^2$ for 6% version and 200 $\mu\text{W}/\text{cm}^2$ for the 8% version
- Works on the mains (220-240V) without any special supplementary ballast
- Easy handling: E27 cap
- Effective lamp life: 4000 hrs*



APPLICATIONS

- Provides the necessary UV-B radiation for reptiles in a terrarium in order to keep them healthy
- Two versions (6% and 8%) in order to adapt to the type of reptile
- Could also be used in certain industrial applications



DIRECTIONS FOR USE

- This lamp emits UV-radiation. Avoid exposure to skin and eyes
- Not suitable for household room illumination
- Burning position: unrestricted
- Lamps comply with EN 60968 (Safety Requirement) and EN 60969 (Performance Requirements) and CE regulations

* Effective life: time to 50% of 100 hours UVB output

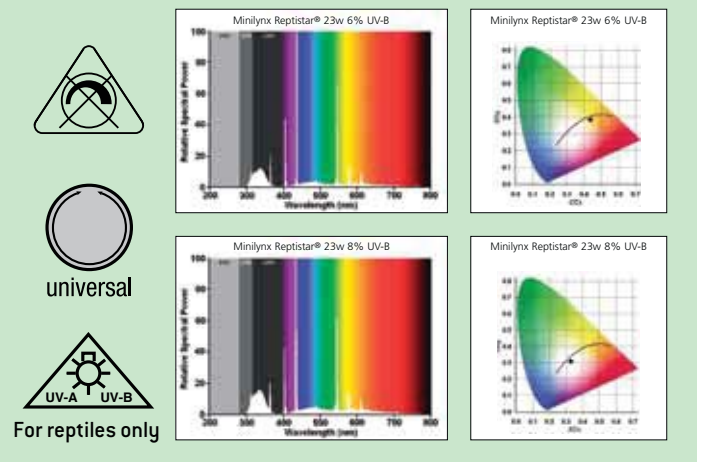
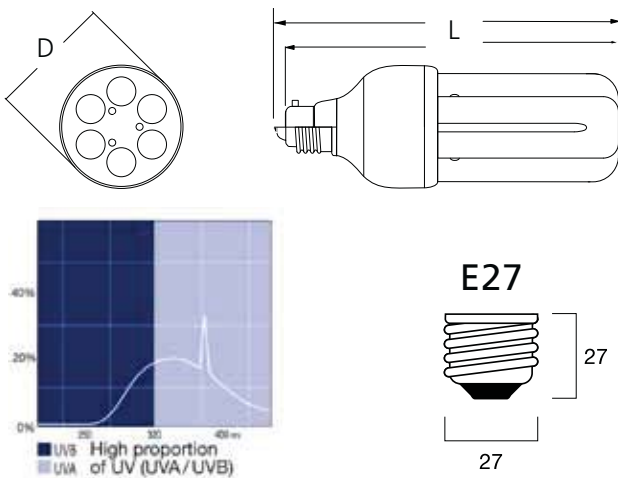

Code	Item description	Watt W	Mains Voltage V	Current A	Dimensions L D mm mm	Cap	Colour Temp. K	Luminous Flux lm	CRI Class	Spectral Power UV-A At 100mm in $\mu\text{W}/\text{cm}^2$	Spectral Power UV-B At 100mm in $\mu\text{W}/\text{cm}^2$	Packing Quantity
0027276	MiniLynx 23W Reptistar 8%UV-B	23	220-240	190	166 57	E27	6500	540	1b	750	200	10

Reptistar - Infrared Reflector

FEATURES

- Converts electric current into infrared radiation

APPLICATIONS

- Provides the necessary infrared radiation for reptiles in terrariums and for other pets like hamsters, mice etc.

DIRECTIONS FOR USE

- Not suitable for household room illumination

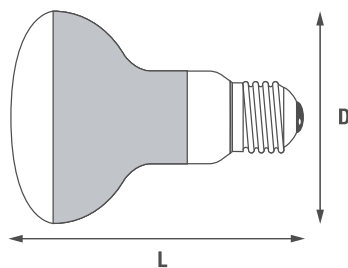

E27

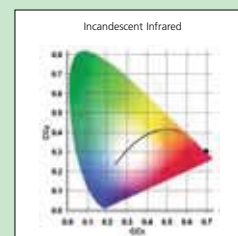
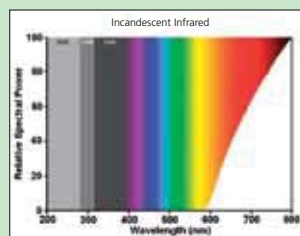
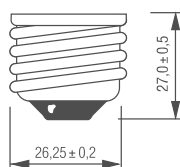

Code	Item description		Dimensions (mm)		Watt W	Volt V	Cap	Packing Quantity
			L	D				
0033005	IR R63 50W Reptistar	Infra Red	103	63	50	230	E27	10
0033006	IR R63 75W Reptistar	Infra Red	103	63	75	230	E27	10
0033007	IR R80 100W Reptistar	Infra Red	110	80	100	230	E27	10
0033004	IR R95 100W Reptistar	Infra Red	130	95	100	230	E27	12

Reptistar - Infra Red Halogen

FEATURES

- Special aluminized reflector for optimal light and infra red distribution
- The higher light level intensity allows for a larger distance from the reptile than with normal incandescent basking spotlights
- Up to triple the life of standard infra red incandescent lamps. (> 2500hrs)
- Can be dimmed
- **Night version available:** the lens blocks the visible light but transmits the infra red and a very small amount of blue light for moonlight effect. Allows reptiles to enjoy warmth during the night too.

APPLICATIONS

- These halogen lamps create warm, sunny areas in the terrarium

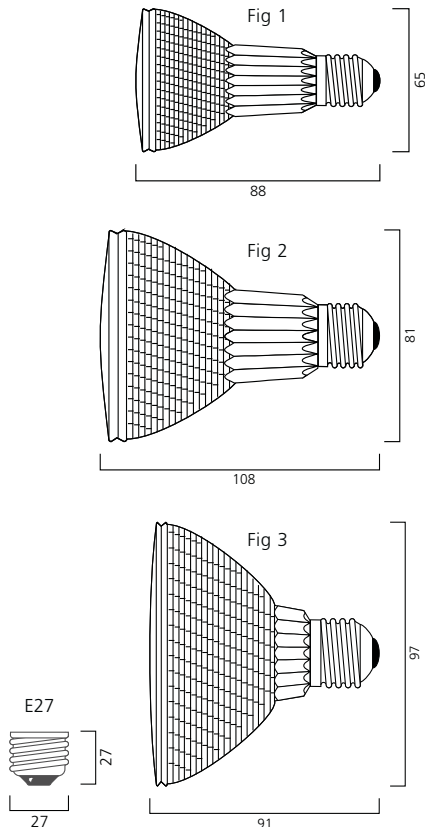

Code	Description	L (mm)	D (mm)	Watt (W)	Volt (V)	Beam angle	Cap	Fig	Packing Quantity
0033050	IR Hi-Spot 63 50W Reptistar	88	65	50	230	25	E27	1	15
0033051	IR Hi-Spot 80 75W Reptistar	108	81	75	230	25	E27	2	15
0033052	IR Hi-Spot 95 100W Reptistar	91	97	100	230	30	E27	3	15
0033053	IR - Night Hi-Spot 95 100W Reptistar	91	97	100	230	30	E27	3	15