

# Halogen airfield lamps – Japanese types

Dimension in mm

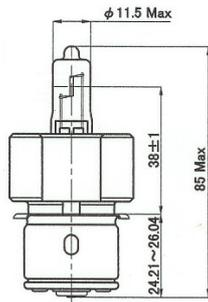

Fig. 1

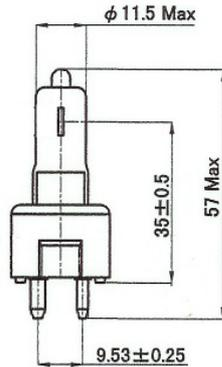

Fig. 2

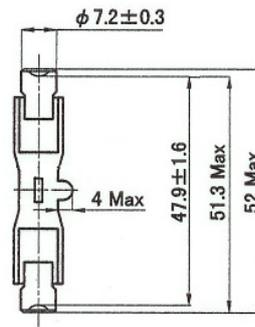

Fig. 3

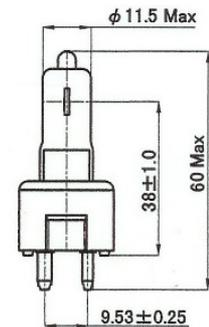

Fig. 4

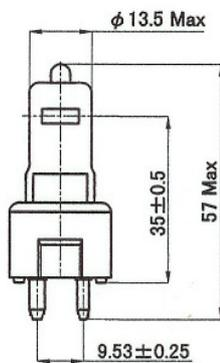

Fig. 5

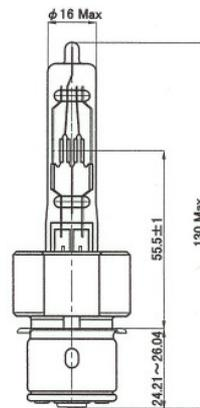

Fig. 6

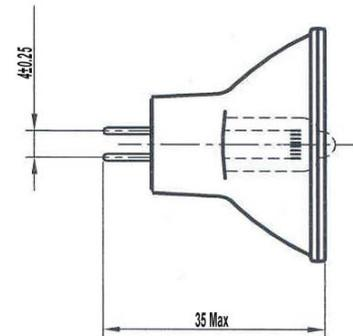

Fig. 7

## Technical and ordering data

Type	Current A	Wattage W	Base	Luminous flux Lm	Average life hrs.	LCL mm	Filament	Fig.	Ordering number
JF 6,6A-30W P	6,6	30	P28s	420	800	38	C-8	1	9248 623 85968
JF 6,6A-30W V3	6,6	30	GZ9,5	330	1000	35	C-8	2	9248 480 85932
JFR 6,6A 35W N/3G	6,6	35	GZ4	-	1500	-	C-6	7	9248 175 85932
JF 6,6A-45/K	6,6	45	R7s	630	1000	-	C-8	3	9248 461 85968
JF 6,6A-60W P	6,6	60	P28s	1100	800	38	C-8	1	9248 622 85968
JF 6,6A-60W V	6,6	60	GY9,5	1200	500	38	C-8	4	9248 298 85970
JF 6,6A-150W V3	6,6	150	GZ9,5	3450	500	35	CBAR-6	5	9248 489 85932
JF 6,6A-200W P	6,6	200	P28s	5200	300	55,5	C-13	6	9248 621 85968
JF 6,6A-200W V3	6,6	200	GZ9,5	4800	500	35	CBAR-6	5	9248 481 85932
JFR 6,6A-200W/P	6,6	200	cable	-	500	-	CBAR-6		9248 244 85968

Issue 5/2005