

 **MAGLITE**[®]



CALIFORNIA, USA  **MAG-LITE**[®]
MAG INSTRUMENT - A



MAG-LED[™] Technology

The Mag Philosophy

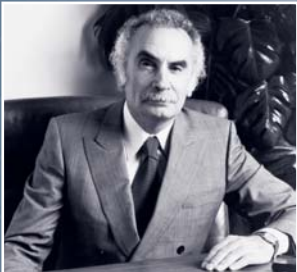

Mag Instrument is dedicated to the highest standards of integrity. We seek performance and a reputation reflecting the very best we can achieve. Each Mag Instrument flashlight represents a culmination of more than 25 years of research, development, testing and continuous state-of-the-art refinement in every precision feature.



Mag Instrument, Late 50's

We are proud to offer products of classic American design and are committed to remaining a U.S.-based manufacturer.

We believe the spirit and character of the company is most clearly defined and expressed by our founder, owner and president Anthony Maglica. Each flashlight is a result of his obsession with fine engineering, craftsmanship and his commitment to perfection. An experimental machinist by training and a manufacturing innovator by practice,

Mr. Maglica has guided his company's growth from a one-man machine shop in 1955 to an enterprise that employs approximately 800 dedicated employees today. But his work does not stop there. Mr. Maglica continues his commitment to quality by continually improving upon the product that bears his name.

Mag Instrument is proud to be a leader in the current renaissance in American manufacturing. Mr. Maglica himself, a fervent believer in the importance of manufacturing in the United States, insists that the manufacture of Mag Instrument's flashlights remain U.S.-based. He has dedicated himself to proving that American products can excel in the global marketplace by using technology to continuously improve quality and reduce costs. Over the last two decades, Mr. Maglica's innovations have enabled Mag Instrument to offer consumers a consistently better value than the competition.

Strengthen American Manufacturing

Mag Instrument is the only flashlight company with significant market share that still manufactures its entire line of flashlights in the United States. Unlike its competitors, Mag

Instrument has chosen not to outsource the manufacturing of its flashlights to foreign countries in order to take advantage of cheap labor and less stringent environmental standards, which may also result in inferior quality. The outsourcing of manufacturing by other U.S. companies has caused hundreds of thousands, if not millions, of jobs in the United States to be lost. Indeed, if Mag Instrument had chosen the path of other flashlight companies, the jobs of its approximately 800 employees in Ontario, California would have been lost.

Table of Contents



- From Top To Bottom:
- Mag Charger® Rechargeable Flashlight
 - Mag-Lite® D Flashlight
 - Mag-Lite® C Flashlight
 - Mini Maglite® AA LED Flashlight
 - Mini Maglite® 2-Cell AA Flashlight
 - Mini Maglite® 2-Cell AAA Flashlight
 - Solitaire® 1-Cell AAA Flashlight

Features & Benefits	2
MAG-LED™ Technology Story	4
Mag-Lite® D Cell LED Flashlights	5
LED Upgrade Module	6
Mini Maglite® AA Cell LED Flashlights	7
Mag Charger® Rechargeable Flashlight System (Ni-Cad)	8
Mag-Lite® D Cell Flashlights	10
Mag-Lite® C Cell Flashlights	11
Mini Maglite® 2-Cell AA Flashlight	12
Mini Maglite® 2-Cell AAA Flashlight	14
Solitaire® 1-Cell AAA Flashlight	15
Replacement Lamps	16
Accessories	18
Premiums & Incentives (Corporate Gifts)	20
Customer Service / Website	22
In The Community	24
Mag Merchandise	25

For warranty details, see your Mag-Lite® product retailer, the package literature, or call Mag Instrument, Inc., at (909) 947-1006.

You may also email: salesdesk@magmail.com or visit our website at www.maglite.com for more information. To find the warranty terms applicable in a particular country, click on "Customer Service" and select that country when prompted.

Trademark Information

The distinctive shapes, styles and overall appearances of all Mag® flashlights, and the circumferential inscriptions extending around the heads of all Mag® flashlights are trademarks of Mag Instrument, Inc. The circumferential inscription on the head of every flashlight signifies that it is an original Mag® flashlight and part of the Mag® family of flashlights. U.S. Trademark Registrations for the shape, style and overall appearance trademarks of Mag® flashlights and for circumferential inscription trademarks of Mag® flashlights include Nos. 1,808,998; 2,074,795; 2,687,693; 2,745,460; 2,765,978 and 2,765,979. ©2007 MAG INSTRUMENT, INC.

Flashlight Features & Benefits



Step 1: Unscrew flashlight head
Step 2: Place head down on table
Step 3: Set flashlight into head



Mini Maglite® AA & AAA flashlights convert quickly to a free standing candle mode, for convenient, hands-free light whenever you need it!

Candle Mode

All Mag-Lite® flashlights feature a high intensity fast focusing adjustable beam.

Backed by Mag Instrument's Renowned Warranty Service.
Limited lifetime warranty in the Western Hemisphere and Japan; ten-year limited warranty elsewhere. See product packaging for details.

A U.S.A. Manufacturer
All Mag® flashlights are designed, patented and manufactured in the U.S.A. May contain some imported components.

Design balanced optics and power for improved performance

Anodized inside and out for improved corrosion resistance and durability

All Mag® flashlights include a spare lamp inside the tail cap.*

Water and shock resistant

High-grade rubber seals in every size flashlight

Precision machined high-strength aluminum alloy cases

Spot to Flood

Mag-Lite® C & D Cell flashlights feature a Cam Action Fast Focusing Beam

Our exclusive cam-driven focusing system changes the beam from a wide angle flood to an intense spot with just a quick twist of the head.

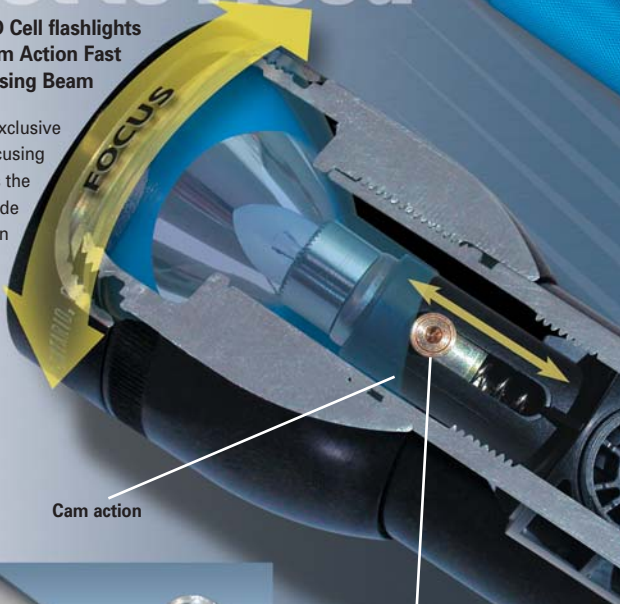

Cam action

Roller bearing



All Mag® Flashlights include a spare lamp safely secured inside the tail cap.*

Spare Lamp

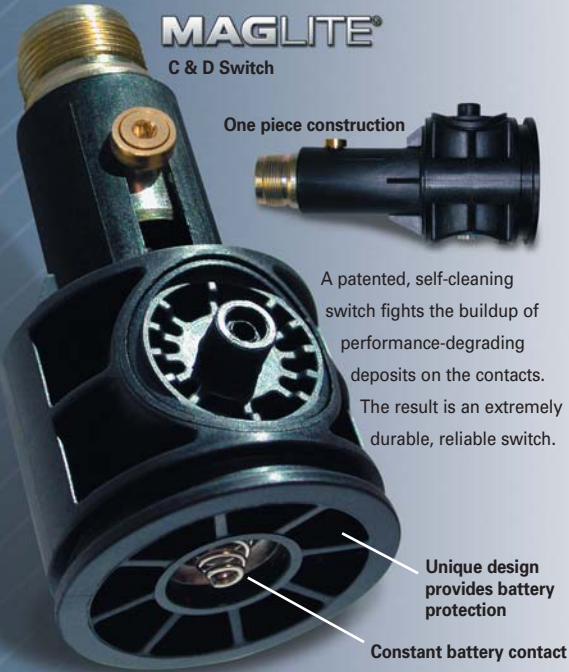

MAGLITE®
C & D Switch

One piece construction

A patented, self-cleaning switch fights the buildup of performance-degrading deposits on the contacts. The result is an extremely durable, reliable switch.

Unique design provides battery protection

Constant battery contact



The Solitaire® flashlight features an innovative extended key lead that allows the light beam and keys to be used together in the same direction.

Mag-Lite® Switch

* (Except 2, 3 Cell AA Mini Maglite® LED flashlights.)

The MAG-LED™ Technology Story



Owner and Founder
Anthony Maglica

Anthony Maglica, known for his obsession with precision engineering, craftsmanship and commitment to perfection, was not satisfied with the performance of a "regular" LED as a usable light source. Mr. Maglica set his sights on producing an LED light source that would have the kind of durability, reliability, and performance Maglite® flashlights are known for. With an emphasis on uncompromising performance, **MAG-LED™ Technology** is the result of that quest.

- The benefits include:
- **A Powerful Projecting Beam** that focuses simply by rotating the head.
 - **Balanced Optics™**, combining a highly refined reflector with a quality LED, for a brilliant adjustable beam.
 - **Intelligent Energy Source Management** (patent pending) balancing high brightness with efficient power usage.

- PLUS:** All of the quality features professionals and consumers expect from a Mag® flashlight:
- Rugged, machined aluminum construction with knurled design.
 - Anodized inside and out for improved corrosion resistance.
 - Water and shock resistant.



Rotate head for powerful focusing beam.

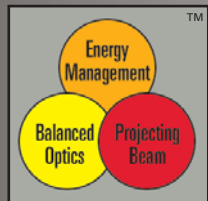

Energy Management, Balanced Optics™, Projecting Beam



Interchangeable Light Sourcing - Use either the installed LED module or the Krypton lamp (stored in the tailcap).



PRODUCT DETAIL INFORMATION BLISTER PACKS:
2-Cell D Package Includes:
 Maglite® LED 2-cell D Flashlight
3-Cell D Package Includes:
 Maglite® LED 3-cell D Flashlight
4-Cell D Package Includes:
 Maglite® LED 4-cell D Flashlight

2, 3, & 4 D-Cell Flashlights with **MAG-LED™ Technology** use a 3 watt LED*

3WATT LED™



Mag-Lite® LED D-Cell flashlights are also offered in a variety of colors (refer to color guide below).

The Maglite® flashlight, renowned for its quality, durability, and reliability, is now available with the new **MAG-LED™ Technology**.

Designed for professional and consumer use, Maglite® LED flashlights build on the experience in craftsmanship, engineering, and advanced technology evident in all Mag® flashlights. The Maglite® flashlight is internationally accepted as the Professional Flashlight®. Built tough enough to last a lifetime, its durability and patented features now combined with the new **MAG-LED™ Technology** make the Maglite® LED flashlight a technologically advanced lighting instrument. Available in 2, 3, & 4 Cell D size, the benefits include:

- **A Powerful Projecting Beam** that focuses simply by rotating the head.
- **Balanced Optics™**, combining a highly refined reflector with a quality LED, for a brilliant adjustable beam.
- **Intelligent Energy Source Management** (patent pending) balancing high brightness with efficient power usage.
- **Interchangeable Light Sourcing** - Use either the installed LED module or the Krypton lamp (stored in the tailcap).

MAG-LITE® LED D-CELL FLASHLIGHT

	2D		3D		4D	
Overall Length:	10 in.	254 mm	12-11/32 in.	313 mm	14-23/32 in.	374 mm
Barrel Diameter:	1-9/16 in.	39.67 mm	1-9/16 in.	39.67 mm	1-9/16 in.	39.67 mm
Head Diameter:	2-1/4 in.	57.00 mm	2-1/4 in.	57.00 mm	2-1/4 in.	57.00 mm
Weight without battery:	14 oz.	402 g	15 oz.	445 g	17 oz.	496 g
Weight with battery:	23 oz.	674 g	30 oz.	856 g	36 oz.	1043 g
LED:	3 Watt*		3 Watt*		3 Watt*	
Energy Management	✓		✓		✓	
Balanced Optics	✓		✓		✓	
Projecting Beam:	✓		✓		✓	
Focusing Beam	✓		✓		✓	
Batteries Required:	(2) D size alkaline		(3) D size alkaline		(4) D size alkaline	

*As rated by supplier of LED.



COLOR GUIDE

LED Upgrade Module

LED Upgrade Module with **MAG-LED™** Technology uses a 3 watt LED*

Upgrade your existing 2, 3, & 4 C or D-Cell Maglite® flashlights to the new **MAG-LED™** Technology.

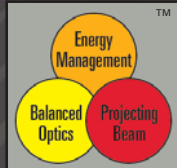

- The benefits include:
- Intelligent Energy Source Management (patent pending) balancing high brightness with efficient power usage.
 - Balanced Optics™, combining a highly refined reflector with a quality LED, for a brilliant adjustable beam.

The Maglite® LED Upgrade Modules are available for all 2, 3, & 4 Cell C & D size Maglite® flashlights. The kits are cell number/size specific i.e. 2 Cell, 3 Cell, 4 Cell and must be matched to a 2, 3, or 4 Cell Maglite® flashlight. Unlike "LED retrofits" that are not made or approved by Mag, these Upgrade Modules were engineered by Mag and are factory-authorized. Their use cannot adversely impact coverage under the Maglite® flashlight Limited Lifetime Warranty.

3WATT LED*



Indicates Size:
2 = 2-Cell
3 = 3-Cell
4 = 4-Cell



	(2) C or D	(3) C or D	(4) C or D
Model Number:	SH32DCW6	SH33DCW6	SH34DCW6
LED:*	3 Watt*	3 Watt*	3 Watt*
Energy Management	✓	✓	✓
Balanced Optics	✓	✓	✓
Projecting Beam:	✓	✓	✓
Focusing Beam	✓	✓	✓
Batteries Required:	(2) C or D size alkaline	(3) C or D size alkaline	(4) C or D size alkaline

*As rated by supplier of LED.
Designed for use in Maglite® flashlights only. Flashlight not included.

Upgrading any C or D size Maglite® flashlight (2, 3, or 4 Cell) is as easy as 1, 2, 3.



- Step 1**
Unscrew the Maglite® flashlight head assembly.
- Step 2**
Unscrew the retaining collar and remove lamp.
- Step 3**
Insert LED Module and replace retaining collar and head assembly.



Mini Maglite® AA-Cell LED

2 & 3 AA-Cell Flashlights with **MAG-LED™** Technology use a 3 watt LED*

3WATT LED*

The new Mini Maglite® LED is crafted after the legendary Mini Maglite® flashlight, an icon of classic American design, famous around the world. Built tough enough to last a lifetime, its durability and patented features are now available with the new **MAG-LED™** Technology. Whether you choose the super bright 2-Cell AA for its smaller size or the longer 3-Cell AA with its even higher performance, these technologically advanced lighting instruments are the ideal personal flashlights. The benefits include:

- **A Powerful Projecting Beam** that focuses simply by rotating the head.
- **Balanced Optics™**, combining a highly refined reflector with a quality LED, for a brilliant adjustable beam.
- **Intelligent Energy Source Management** (patent pending) balancing high brightness with efficient power usage.
- **Candle Mode** Unscrew flashlight head, place head down on stable flat surface and set flashlight barrel into head.



MINI MAGLITE® LED AA FLASHLIGHT

	2AA	3AA
Overall Length:	6.607 in. 167.8 mm	8.596 in. 218.3 mm
Barrel Diameter:	.709 in. 18 mm	.709 in. 18 mm
Head Diameter:	1 in. 25.4 mm	1 in. 25.4 mm
Weight without battery:	2.4 oz. 68.04 g	2.88 oz. 81.64 g
Weight with battery:	4.15 oz. 117.75 g	5.44 oz. 154.22 g
LED:	3 Watt*	3 Watt*
Energy Management	✓	✓
Balanced Optics	✓	✓
Projecting Beam:	✓	✓
Focusing Beam	✓	✓
Batteries Required:	(2) AA size alkaline	(3) AA size alkaline

*As rated by supplier of LED.



COLOR GUIDE

Mag Charger® Rechargeable Flashlight System (Ni-Cad)

FEATURES

- Easily replaced high-intensity halogen lamp
- 1/4 turn, cam action focus, spot-to-flood
- Self-cleaning rotary switch, 3 position, On, Off, and Signal (Manual, Momentary On-Off)
- Charger operates on A/C or D/C current
- Flashlight can be charged in any position.
- Highly polished, scientifically designed, metallic reflector, withstands extreme temperatures.
- Tempered glass lens.
- Durable extra hard anodized finish
- Limited Lifetime Warranty in the Western Hemisphere and Japan; Ten-Year Limited Warranty Elsewhere.
- Individually serial numbered
- Flashlight designed, patented and manufactured in U.S.A. May contain some imported components. Certain accessories imported.

Without question, our ultimate lighting tool. Refined and enhanced over many years of dedicated service, the Mag Charger® Rechargeable Flashlight System is chosen by professionals worldwide.

Mag Charger® Rechargeable Flashlight Only (ARXX014)



Spare Halogen Lamp Included in Tail Cap

- (2) Detachable mounting brackets included allows for multiple charging locations, quick movement from car to home
- Mounts securely in any position



Charging Cradle (ARXX025)

Includes Two Mounting Brackets (ARXX088)

12V DC Cigarette Lighter Adapter (ARXX045)



Rechargeable Battery Pack (ARXX075)



120V AC Converter (ARXX035)



System No. 1 Available In Hang Pack



Now With Brighter, Next-Generation Halogen Lamp¹

Versatile *Tight spot or wide-angle flood* Patented quick-focusing "continuous cam-action" operates with a quarter-turn of the flashlight head – *Charging Cradle* mounts securely in any position with minimal space, AC or DC – Flashlight can be charged in any position.

Reliable A proven performer all day, every day; all night, every night – *Self-cleaning rotary switch* 3-position; on, off, and signal (manual, momentary on-off).

Durable Sleek black finish, hard-anodizing inside and out for improved durability – Water resistant seals throughout for resistance to weather and harsh environmental conditions.

Fit and Finish Precision machined high-strength aluminum alloy case – Individually serial numbered for identification – A *back-up Halogen lamp* is stored in the tailcap, o-ring sealed.

Performance *Next generation optical reflector* A high-tech metallic reflector, combined with a tempered glass lens that delivers superior optical performance – up to *2-Hours On-Time** High-capacity rechargeable NiCad battery provides over 1,000 hours of operational life – *Now With Brighter, Next-Generation Halogen Lamp.¹*

Purchase with Confidence Mag's warranty (limited lifetime warranty in Western Hemisphere and Japan, ten-year limited warranty elsewhere) is backed by Mag's international network of Warranty Service Centers.

¹ The prior generation lamp, introduced in early 2002, produced up to 41,200 peak beam candlepower (PBC). The newest-generation lamp was found in June 2005 tests to produce up to 51,700 PBC – a 25% increase. All performance figures are approximate. Actual performance can vary due to manufacturing variations in flashlights, lamps and batteries. Note: the battery discharge rate when not in use is approximately 1% per day.

System No.1 Shown. 7 Different System Combinations Available In A Multi-colored Chipboard Display Carton. Model Numbers on Chart

MAG CHARGER® RECHARGEABLE FLASHLIGHT SYSTEM (NI-CAD)

Overall Length:	12-19/32 in.	319.79 mm
Barrel Diameter:	1-9/16 in.	39.57 mm
Head Diameter:	2-5/16 in.	58.72 mm
Weight without battery:	18 oz.	510 g
Weight with battery:	32 oz.	907 g
Peak Beam Candlepower:*	Up to 51,700	
Battery Life continuous on time:*	Up to 2 hours	
Battery voltage output:	6 volts	
Battery Required:	Five (5) 1/2 D size Ni-CAD Pack (Nickel-Cadmium)	

* Peak Beam Candlepower and Battery Life Continuous on time are approximate and may vary between flashlights, lamps, and/or batteries.

ITEM NO.	SYSTEM NO. MODEL NO.	CHECK MARK SHOWS CONTENTS OF EACH SYSTEM						
		1	2	3	4	5	6	7
1	Rechargeable Flashlight	✓	✓	✓	✓	✓	✓	✓
2	Charging Cradle	✓	✓	✓	✓	✓	✓	✓
3	Battery Pack	✓	✓	✓	✓	✓	✓	✓
4	Mounting Brackets (2)	✓	✓	✓	✓	✓	✓	✓
5	120 Volt Converter	✓	✓					✓
6	Cigarette Lighter Adapter, (12 Volt)	✓	✓	✓				
7	230 Volt Converter (Euro Only)				✓	✓		
8	Straight Wire Only, (12 Volt)						✓	✓



Mag Instrument, Inc. is a proud participant in the RBRC (Rechargeable Battery Recycling Corporation). By recycling Ni-Cd rechargeable batteries, you are helping to keep Ni-Cd batteries out of the solid waste stream. When you throw away a Ni-Cd battery, it eventually ends up in a landfill or municipal incinerator. By recycling your used Ni-Cd batteries through Mag Instrument's Battery Recycling Program, you are helping to create a cleaner and safer environment for generations to come. For more information about the RBRC, visit www.rbrc.com.

Call: (909) 947-1006, email: salesdesk@magmail.com or visit our website: www.maglite.com

Mag-Lite® D-Cell Flashlights

Every Mag-Lite® flashlight embodies a precise balance of refined optics, efficient power, durability and quality. Each Mag-Lite® D-Cell flashlight includes two high intensity White Star® Krypton Gas Lamps for enhanced brilliance and extended range.

FEATURES

- High-intensity light beam
- 1/2 turn, cam action focus, spot-to-flood
- Self-cleaning rotary switch, 3 position, On, Off, and Signal (Manual, Momentary On-Off)
- Spare replacement lamp safely secured in the tailcap (see page 3)
- High-strength aluminum alloy cases
- O-ring sealed for water resistance

- Limited Lifetime Warranty in the Western Hemisphere and Japan; Ten-Year Limited Warranty Elsewhere.
- Individually serial numbered
- All Mag® flashlights are designed, patented and manufactured in the U.S.A. May contain some imported components.

3-Cell D/2-Cell AA Mag-Lite® Lite Pack



2-Cell D Mag-Lite® Hang Pack



2-cell D Mag-Lite® flashlight

3-cell D Mag-Lite® flashlight

4-cell D Mag-Lite® flashlight

5-cell D Mag-Lite® flashlight

6-cell D Mag-Lite® flashlight

Mag-Lite® D-Cell flashlights are also offered in a variety of colors (refer to color guide below).

COLOR GUIDE



Camo - 3 D-Cell Only

MAG-LITE® D-CELL FLASHLIGHT

	2D	3D	4D	5D	6D
Overall Length:	10 in. 254 mm	12-11/32 in. 313 mm	14-23/32 in. 374 mm	17-1/8 in. 434 mm	19-1/2 in. 495 mm
Barrel Diameter:	1-9/16 in. 39.67 mm	1-9/16 in. 39.67 mm	1-9/16 in. 39.67 mm	1-9/16 in. 39.67 mm	1-9/16 in. 39.67 mm
Head Diameter:	2-1/4 in. 57.00 mm	2-1/4 in. 57.00 mm	2-1/4 in. 57.00 mm	2-1/4 in. 57.00 mm	2-1/4 in. 57.00 mm
Weight without battery:	14 oz. 402 g	15 oz. 445 g	17 oz. 496 g	19 oz. 547 g	21 oz. 598 g
Weight with battery:	23 oz. 674 g	30 oz. 856 g	36 oz. 1043 g	43 oz. 1233 g	50 oz. 1417 g
Peak Beam Candlepower:*	Up to 16,200	Up to 22,000	Up to 23,000	Up to 32,200	Up to 30,000
Battery Life continuous on time:*	9-10 hours	9-10 hours	9-10 hours	9-10 hours	9-10 hours
Battery voltage output:	3.0 volts	4.5 volts	6.0 volts	7.5 volts	9.0 volts
Batteries Required:	(2) D size alkaline	(3) D size alkaline	(4) D size alkaline	(5) D size alkaline	(6) D size alkaline

* Peak Beam Candlepower and Battery Life Continuous on time are approximate and may vary between flashlights, lamps, and/or batteries.

Mag-Lite® C-Cell Flashlights

FEATURES

- High-intensity light beam
- 1/2 turn, cam action focus, spot-to-flood
- Self-cleaning rotary switch, 3 position, On, Off, and Signal (Manual, Momentary On-Off)
- Smaller & lighter than the D cell

- Spare lamp safely secured in the tailcap (see page 3)
- High-strength aluminum alloy cases
- O-ring sealed for water resistance
- Optional xenon lamp (see page 16)
- Limited Lifetime Warranty in the Western Hemisphere and Japan; Ten-Year Limited Warranty Elsewhere.
- Individually serial numbered
- All Mag® flashlights are designed, patented and manufactured in the U.S.A. May contain some imported components.

The Mag-Lite® C-Cell flashlight embodies the same precise balance of refined optics, efficient power, durability and quality as the D-Cell Flashlights in a smaller, lighter weight design. Each Mag-Lite® C-Cell flashlight includes two high intensity White Star® Krypton Gas Lamps for enhanced brilliance and extended range.

2-Cell C Chipboard Display Carton



3-Cell C Mag-Lite® Hang Pack



4-cell C Mag-Lite® flashlight



9-cell C Mag-Lite® flashlight



2-cell C Mag-Lite® flashlight

MAG-LITE® C-CELL FLASHLIGHT

	2C	3C	4C
Overall Length:	8-15/16 in. 227 mm	10-7/8 in. 276 mm	12-13/16 in. 325 mm
Barrel Diameter:	1-1/4 in. 31.75 mm	1-1/4 in. 31.75 mm	1-1/4 in. 31.75 mm
Head Diameter:	2-1/4 in. 57.00 mm	2-1/4 in. 57.00 mm	2-1/4 in. 57.00 mm
Weight without battery:	11 oz. 311 g	12 oz. 340 g	13 oz. 368 g
Weight with battery:	15 oz. 445 g	19 oz. 541 g	22 oz. 637 g
Peak Beam Candlepower:*	Up to 14,400	Up to 20,000	Up to 24,800
Battery Life continuous on time:*	5 hours	5 hours	5 hours
Battery voltage output:	3.0 volts	4.5 volts	6.0 volts
Batteries Required:	(2) C size alkaline	(3) C size alkaline	(4) C size alkaline

* Peak Beam Candlepower and Battery Life Continuous on time are approximate and may vary between flashlights, lamps, and/or batteries.

D & C cell Mag-Lite® flashlights are available in hang packs or chipboard display cartons.



Black - 2, 3, & 4 C-Cell

COLOR GUIDE

Mini Maglite® 2-Cell AA Flashlight

Packaging Options

Until its inception, no flashlight of this size incorporated the features, functions, and unique design elements of our Mini Maglite® AA flashlight. Now an icon of classic American design, and famous around the world for its brightness, quality, durability, and dependability.

Super Bright Krypton Lamp™



AA Standard Package - (M2A016) Black



AA Holster Package - (M2A03H) Red



AA Combo Package - (M2A11C) Blue

FEATURES

- High-intensity light beam
- 1/2 turn, twist focus, spot-to-flood (see fig. C)
- Patented Candle Mode (see fig. B)
- Spare lamp safely secured in the tailcap (see fig. A)
- High-strength aluminum alloy case
- O-ring sealed for water resistance
- Vented tailcap (patented) reduces chance of gas buildup
- Compact/lightweight construction
- Limited Lifetime Warranty in the Western Hemisphere and Japan; Ten-Year Limited Warranty Elsewhere.
- All Mag® flashlights are designed, patented and manufactured in the U.S.A. May contain some imported components.

Figure A - Mini Maglite® AA flashlight spare lamp out of tail cap



Spare Lamp

Figure B The Mini Maglite® AA flashlight candle mode feature is for convenient, hands-free light whenever you need it.

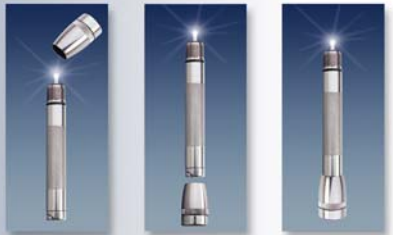

Step 1: Unscrew flashlight head
Step 2: Place head down on table
Step 3: Set flashlight into head

PRODUCT DETAIL INFORMATION FOR BLISTER PACKS:

- AA Standard Package Includes:** Mini Maglite® 2-cell AA Flashlight & two AA-cell premium alkaline batteries.
- AA Holster Package Includes:** Mini Maglite® 2-cell AA Flashlight, black polypropylene holster & two AA-cell premium alkaline batteries.
- AA Combo Package Includes:** Mini Maglite® 2-cell AA Flashlight, lens holder/anti roll device, lens set (red, blue, & clear), wrist lanyard, pocket clip & two AA-cell premium alkaline batteries.

PRODUCT DETAIL INFORMATION FOR PRESENTATION BOX:

Mini Maglite® 2-Cell AA (Presentation Box) Includes: Mini Maglite® 2-cell AA Flashlight, two AA cell premium alkaline batteries and presentation box.



The Mini Maglite® flashlight also features a fast-focus beam that adjusts from spot-to-flood with a turn of the head.

MINI MAGLITE® 2-CELL AA FLASHLIGHT

Overall Length:	5-3/4 in.	146.00 mm
Barrel Diameter:	23/32 in.	18.23 mm
Head Diameter:	1 in.	25.40 mm
Weight without battery:	2.1 oz.	60 g
Weight with battery:	3.8 oz.	107 g
Peak Beam Candlepower:*	Up to 2952	
Battery Life continuous on time:*	5.5 hours	
Battery voltage output:	3.0 volts	
Batteries Required:	Two (2) AA size alkaline	

* Peak Beam Candlepower and Battery Life Continuous on time are approximate and may vary between flashlights, lamps, and/or batteries.



Mini Maglite® AA flashlight in Presentation Box (M2A01L) Black

COLOR GUIDE



Mini Maglite® 2-Cell AAA Flashlight

The Mini Maglite® 2-Cell AAA flashlight has all the same features and functions as the Mini Maglite® AA flashlight in a smaller, lighter version for ease of use and storage.

FEATURES

- High-intensity light beam
- 1/2 turn, twist focus, spot-to-flood
- Patented Candle Mode (see fig. B, page 12)
- Spare lamp safely secured in the tailcap (see fig. A, page 12)
- High-strength aluminum alloy case
- O-ring sealed for water resistance
- Vented tailcap (patented) reduces chance of gas buildup
- Compact/lightweight construction
- Limited Lifetime Warranty in the Western Hemisphere and Japan; Ten-Year Limited Warranty Elsewhere.
- Flashlight designed, patented and manufactured in the U.S.A. May contain some imported components.



Mini Maglite® AAA flashlight in Hang Pack (M3A116) Blue Includes: Two AAA-cell premium alkaline batteries and pocket clip



Mini Maglite® AAA flashlight in Presentation Box (M3A032) Red Includes: Two AAA-cell premium alkaline batteries and pocket clip

MINI MAGLITE® 2-CELL AAA FLASHLIGHT

Overall Length:	5 in.	127.00 mm
Barrel Diameter:	1/2 in.	12.70 mm
Head Diameter:	3/4 in.	19.00 mm
Weight without battery:	0.9 oz.	26 g
Weight with battery:	1.7 oz.	49 g
Peak Beam Candlepower:*	Up to 488	
Battery Life continuous on time:*	2 hours	
Battery voltage output:	3.0 volts	
Batteries Required:	Two (2) AAA size alkaline	

* Peak Beam Candlepower and Battery Life Continuous on time are approximate and may vary between flashlights, lamps, and/or batteries.

Solitaire® 1-Cell AAA Flashlight

Weighing less than one ounce (with battery) and about three inches in length, the Mag-Lite® Solitaire® Single Cell AAA flashlight offers the same precision engineering and craftsmanship found in every Mag-Lite® flashlight. With its unique shape, the Mag-Lite® Solitaire® flashlight fits conveniently into pockets, purses, attache cases, etc.

FEATURES

- High-intensity light beam
- Twist focus, spot-to-flood
- Innovative extended key lead allows the light beam and keys to be used together in the same direction
- Spare lamp safely secured in the tailcap (see fig. A page 12)
- High-strength aluminum alloy case
- O-ring sealed for water resistance
- Vented tailcap (patented) reduces chance of gas buildup
- Compact/lightweight construction
- Limited Lifetime Warranty in the Western Hemisphere and Japan; Ten-Year Limited Warranty Elsewhere.
- Flashlight designed, patented and manufactured in the U.S.A. May contain some imported components.



Mag-Lite® Solitaire® flashlight in Hang Pack (K3A036) Red Includes: One AAA-cell premium alkaline battery and key lead



Mag-Lite® Solitaire® flashlight in Presentation Box (K3A112) Blue Includes: One AAA-cell premium alkaline battery and key lead



(Keys not included.)

SOLITAIRE® 1-CELL AAA FLASHLIGHT

Overall Length:	3-3/16 in.	81.00 mm
Barrel Diameter:	1/2 in.	12.70 mm
Head Diameter:	1/2 in.	12.70 mm
Weight without battery:	0.4 oz.	13 g
Weight with battery:	0.8 oz.	24 g
Peak Beam Candlepower:*	Up to 213	
Battery Life continuous on time:*	3.5 hours	
Battery voltage output:	1.5 volts	
Battery Required:	One (1) AAA size alkaline	

* Peak Beam Candlepower and Battery Life Continuous on time are approximate and may vary between flashlights, lamps, and/or batteries.

COLOR GUIDE



Black Red Silver Blue Gray

COLOR GUIDE



Black Red Silver Blue Gray

Call: (909) 947-1006, email: salesdesk@magmail.com or visit our website: www.maglite.com

Quality Replacement Lamps

Xenon

Maglite® C & D Cell
The Ultimate Upgrade™
 Move Up To Xenon!
 Up To 100% Brighter!

Mag-num Star® Xenon lamps are now available for C & D Cell genuine Mag-Lite® flashlights. Upgrade today and experience the next generation in lamp technology.

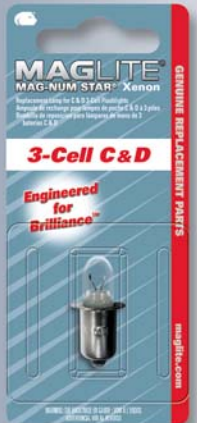

* Mag-Lite® C and D-Cell Flashlight Mag-num Star® Xenon C and D-Cell Replacement Lamp (LMSA201-301-401-501-601) (2 through 6 cell) 1 Per Pack

Quality and dependability are the hallmarks of our flashlights. We insist upon the same quality and dependability for every lamp and accessory. Each Mag-Lite® and Mini Maglite® lamp is specifically designed to work in conjunction with the reflector to deliver optimum performance.

¹ Measured against prior-generation (Krypton) Mag-num Star® lamps, peak beam candlepower ("PBC") of new (as of early 2003) Xenon Mag-num Star® lamp ranged from 100% higher for 2D-cell lamp to 27% higher for 6D-cell lamp, average PBC increase across the range of lamps (2D-cell through 6D-cell) being 59%. All performance figures are approximate. Actual performance can vary due to manufacturing variations in flashlights, lamps, and/or batteries.

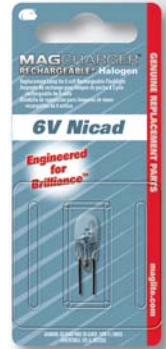

* Mag Charger® Rechargeable Flashlight Halogen Replacement Lamp (LR00001) 1 Per Pack



Halogen

Better, Brighter, Next-Generation Halogen Lamp³

The improved Mag-Lite® Halogen lamps now come as standard "factory equipment" on the Mag Charger® Rechargeable Flashlight System and are available separately. Upgrade today and experience the next generation in lamp technology.

³ The prior generation lamp, introduced in early 2002, produced up to 41,200 peak beam candlepower (PBC). The newest-generation lamp was found in June 2005 tests to produce up to 51,700 PBC - a 25% increase. All performance figures are approximate. Actual performance can vary due to manufacturing variations in flashlights, lamps and batteries.

* Mag-Lite® C and D-Cell Flashlight White Star® Krypton C and D-Cell Replacement Lamp (LWSA201-301-401-501-601) (2 through 6 cell) 2 Per Pack

Krypton

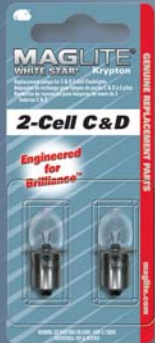

Maglite® C & D Cell
White Star® Replacement Lamps Now Up To 69% Brighter²

White Star® Krypton lamps are installed as "original equipment" on all C & D cell genuine Mag-Lite® flashlights. Upgrade your existing flashlight today and experience the next generation in White Star® lamp technology.

² Measured against prior-generation White Star® lamps, peak beam candlepower ("PBC") of new (as of early 2003) White Star® lamp ranged from 69% higher for 3D-cell lamp to 20% higher for 6C-cell lamp, average PBC increase across the range of lamps (2-cell and 6-cell) being 48%. All performance figures are approximate. Actual performance can vary due to manufacturing variations in flashlights, lamps, and/or batteries.



High Intensity Mini Maglite® AA, Mini Maglite® AAA, and Solitaire® Flashlights

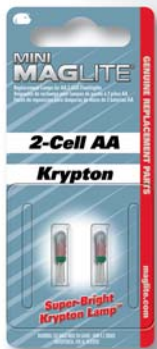

* Mini Maglite® AA Flashlights 2-Cell AA Krypton Replacement Lamp (LM2A001) 2 Per Pack

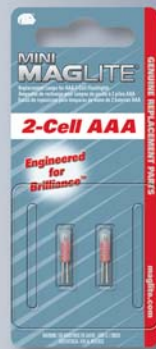

* Mini Maglite® AAA Flashlights 2-Cell AAA Replacement Lamp (LM3A001) 2 Per Pack

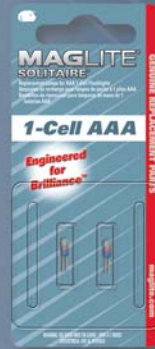

* Solitaire® Flashlight 1-Cell AAA Replacement Lamp (LK3A001) 2 Per Pack



Miniature

*Enlarged to show detail

Accessories

Mounting Brackets

Available for D and C Cell Mag-Lite® and AA Mini Maglite® flashlights.



Mag-Lite® C-Cell flashlight mounting bracket (ASXCAT6)



Mag-Lite® D-Cell flashlight mounting bracket (ASXD026)

Mini Maglite® 2-Cell AA flashlight mounting bracket (AM2A496) (not shown)

Mini Maglite® Belt Holsters

Black Cordura® Nylon Full Flap Holster, Mini Maglite® 2-Cell AA Flashlight (AM2A056)
Also available in black for Mini Maglite® 2-Cell AAA Flashlight (AM3A026)



- Rugged woven nylon
- Weather resistant, locked stitch, nylon thread
- Velcro® interlocking front and back flaps for quick attachment and sure retention

Camo Cordura® Nylon Full Flap Holster, Mini Maglite® 2-Cell AA Flashlight (AM2A136)



- Rugged woven nylon
- Weather resistant, locked stitch, nylon thread
- Velcro® interlocking front and back flaps for quick attachment and sure retention

Ballistic Fabric Full Flap Holster, Mini Maglite® 2-Cell AA Flashlight (AM2A026)



- Trilaminare Accumold® construction
- Ballistic grade woven fabric
- High density closed cell foam center.
- Smooth Coptex™ knit lining.
- Velcro® interlocking flap closure.

Black Leather Holster, Mini Maglite® 2-Cell AA Flashlight (AM2A026)



- Full grain genuine leather
- Heavy duty, weather resistant, locked stitch thread
- Solid brass snap for quick attachment

Accessories



2-Cell AA Accessory Pack (AM2A016) Includes: Red, Blue, and Clear lenses, anti-roll device/lens holder, Wrist lanyard, & Pocket clip



Red (ASXX798)



Yellow (ASXX508)



White (ASXX808)

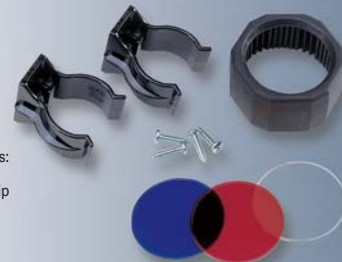

D-Cell Accessory Pack (ASXX376) Includes a rubber Anti-roll device/Lens holder; Red, Clear & Blue Lenses & two D-Cell mounting Brackets (Anti-roll device and lenses also fit C-Cell flashlights)

Traffic Wand Kits with reflective tape for C-Cell & D-Cell only.



C-Cell Leather Belt Holder Plain (ASXC046)

D-Cell Leather Belt Holder Plain (ASXD036)
Basketweave (ASXD056) (not shown)



NVG/Infra-Red



C & D Cell Lens Holder

AA Cell Lens Holder

C & D Cell NVG Lens

AA Cell NVG Lens

C & D Cell Infra-Red Lens

AA Cell Infra-Red Lens

D Cell Mag-Lite® Flashlight with Lens Holder and NVG Lenses Installed

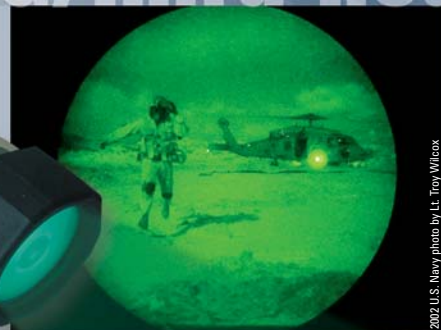

Mag® Night Vision Green (NVG) Lenses block Infra-Red light while transmitting visible light. **Mag® Infra-Red Lenses** block 99-100% of the visible light from our flashlights allowing for a maximum of Infra-Red output while remaining extremely covert. These lenses tremendously improve the image received by night vision goggles, Starlight, Infra-Red and night vision scopes without showing your light source.

2002 U.S. Navy photo by Lt. Troy Wilcox

Premiums, Incentives and Corporate Gifts

Mag-Lite® Flashlights make “brilliant” corporate gifts. Thousands of organizations all over the world have discovered that our high perceived value and reputation for quality and design produce exceptional results.

Our customizing capabilities allow your company name, logo, or message to become a permanent addition to any Mag-Lite® Flashlight. Your artwork can be duplicated precisely with our fully computerized laser engraving process.



Mag-Lite® D-Cell flashlight with barrel engraving



Mag-Lite® C-Cell flashlight with head engraving



Mini Maglite® AA flashlight with barrel engraving



Mini Maglite® AAA flashlight with head engraving

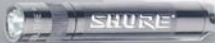

Solitaire® flashlight with barrel engraving

IMPRINT AREA

	Head	Barrel
Solitaire®	N/A	5/16" x 1-1/4"
Mini Maglite® AAA	7/16" x 5/8"	5/16" x 1-1/4"
Mini Maglite® AA	5/8" x 3/4"	7/16" x 2-1/8"
Mag-Lite® 2-Cell C	1-7/16" x 1"	3/4" x 2-3/4"
Mag-Lite® 3-Cell C	1-7/16" x 1"	3/4" x 3-3/4"
Mag-Lite® 2-Cell D	1-7/16" x 1"	1" x 2-3/4"
Mag-Lite® 3-Cell D	1-7/16" x 1"	1" x 3-3/4"

SPECIAL OPTIONS:

The special options listed below are subject to: 10,000 unit minimum, 4-6 week leadtimes, and in some cases additional cost.

- Custom Flashlight colors
- Custom Hot Foil Stamping on Presentation Box



Solitaire®/Victorinox® Classic Knife Combination Pack, Black Flashlight (K3A492) Special Colors on Request



Mini Maglite® AA-Cell flashlight in presentation box with barrel engraving



Mini Maglite® AAA-Cell flashlight in presentation box with head engraving

All presentation box exteriors have textured surfaces with silver hot foil stamping on embossed characters. All three presentation boxes (AA, AAA & Solitaire®) can be customized with your logo.



Mini Maglite® Intermediate Presentation Box with special option Silver Hot Foil Stamping



Mini Maglite® 2-Cell AA Presentation Box with special option Silver Hot Foil Stamping



Mini Maglite® 2-Cell AA Presentation Box with special option Red Hot Foil Stamping



Solitaire® standard presentation box with Silver Hot Foil Stamping



Solitaire® flashlight with barrel engraving

(Keys not included.)



Our unique patented key lead allows you to use keys and the light beam in the same direction. Smooth contouring shape fits conveniently into pocket, purses, attache cases, etc.

Commitment to Customer Service

Our award winning service is just one of the reasons that Maglite® Flashlight products continue to dominate the flashlight industry. Every Mag employee involved in the customer order management cycle continually strives to process every order on time, complete and accurately - every time!

What's New

From the homepage find out what's new at maglite.com.

MAGLITE | THE MAGLITE® FLASHLIGHT | THE COMPANY | IN THE COMMUNITY | CUSTOMER SERVICE | DISTRIBUTOR INFO

store locator warranty service centers spare parts info contact/feedback

A Work Of Art That Works®

Featured Links

- New LED Flashlights
- What's New
- Featured Links
- Register Your Flashlight

MAG-LED™ NEW LED FLASHLIGHTS

LEGAL | Privacy Policy ©2001-2006 Mag Instrument, Inc. All Rights Reserved Ontario, California U.S.A.

Visit our website for the latest information on Mag-Lite® products.

Need a Part? Need Service?

Ordering spare parts, locating the nearest warranty service center or troubleshooting your Mag-Lite® product is just a click away...

If your Mag-Lite® flashlight ever needs service... A network of Authorized Warranty Service Centers is there for you.

Visit maglite.com for the location nearest you.

Look for the window decal.



Warranty Service Centers

Authorized U.S. & International Warranty Service Centers

Within the U.S.A. Please Select a State

Outside the U.S.A. Please Select a Country

Mag Instrument, Inc. 2275 South Midway Avenue P.O. Box 10000 Ontario, California 91761 U.S.A.

Mag Business Hours: Monday - Friday 8:00 am - 5:00 pm Pacific Time
Saturday 9:00 am - 12:00 pm Pacific Time
Sunday 10:00 am - 4:30 pm Pacific Time

Spare Parts

To obtain general information on warranty claims, troubleshooting your product, inspection and maintenance, and operating instructions please visit the [Customer Service](#) page.

If you need to identify a specific part and/or obtain a part number reference please visit [Spare Parts](#).

If you are unsure of the part you require or need assistance in determining the problem please contact us by email, phone, or fax.

Mag Instrument, Inc. 2275 South Midway Avenue P.O. Box 10000 Ontario, California 91761 U.S.A.

Mag Business Hours: Monday - Friday 8:00 am - 5:00 pm Pacific Time
Saturday 9:00 am - 12:00 pm Pacific Time
Sunday 10:00 am - 4:30 pm Pacific Time

Mag Instrument, Inc. 2275 South Midway Avenue P.O. Box 10000 Ontario, California 91761 U.S.A.

Mag Business Hours: Monday - Friday 8:00 am - 5:00 pm Pacific Time
Saturday 9:00 am - 12:00 pm Pacific Time
Sunday 10:00 am - 4:30 pm Pacific Time

Browse the many amazing stories involving Mag-Lite® products we have received over the years.

Mag Amazing Stories

Select A Category to View Amazing Stories:

Survival

Show Stories >

Select A Product to View Amazing Stories:

Mag-Lite® Solitaire® Single Cell AAA Flashlight

Show Stories >

To Submit a Mag Amazing Story

Mag Amazing Stories

World Trade Center 1

A quick story, on Sept 11, 2001, me and 35 of my fellow workers were working 6 levels under the World Trade Center in NYC. At approximately 8:55 AM that morning we were given a heads up that a plane had crashed into the adjacent North Tower (we had been previously involved in the 1993 bomb blast). We ran 7 stories up the fire exit to the street level and escaped with our lives. We were unaware that one of our coworkers was left in the bathroom. The lights went out. Totally black 7 stories underground, except for his Mag-Lite!® The technician who has bad eyesight and bad hearing made his way up the stairs and out of the building as the second plane hit the south side of the south tower, directly above the fire exit. He barely made it across the street as the building began to collapse, steel, glass, people, raining down on him. Without his Mag-Lite!® he would have been buried alive. Thank You, New York, NY

Catalog

Select A Product

D-Cell MAGLITE® FLASHLIGHT

Size: 2D Cell

Color: [Color Selection]

Click on the color buttons to view the selected color flashlight

Mag Instrument, Inc. 2275 South Midway Avenue P.O. Box 10000 Ontario, California 91761 U.S.A.

See product specifications of all our Mag-Lite® and Mini Maglite® flashlights. From part numbers to the circumference of the D cell Mag-Lite® head, you'll find everything you ever wanted to know about Mag-Lite® products.

Anatomy

Specifications

Mouse over part number or Rubicon for photo of part

1 2 3 4 5 6 7 8 9 10 11 12 13 14 15 16 17 18

Mag Instrument, Inc. 2275 South Midway Avenue P.O. Box 10000 Ontario, California 91761 U.S.A.

In The Community

TOGETHER WE PREPARE



Together, we can save a life



The American Red Cross is partnering with Mag Instrument to build awareness and support for the organization's Together We Prepare initiative.

A new nationwide campaign to help Americans prepare for traditional disasters such as house fires or hurricanes or emerging new threats, the Together We Prepare initiative challenges people to take five proactive steps to help them make their families, schools, neighborhoods and workplaces safer. The five simple steps include: make a plan, build a kit, get trained, volunteer and give blood. The partnership is focusing on the second step, build a kit, educating consumers on what to include in a disaster supplies kit. When evacuating or sheltering in place, a disaster supplies kit can save lives. One important component of a disaster supplies kit is a flashlight.



Mag Instrument is a proud financial sponsor of the American Red Cross "Together We Prepare™" Initiative. Use of these names is by permission but implies no product endorsement. Learn more about the Initiative at www.redcross.org or by calling 800-797-8022.



National Law Enforcement Officers Memorial

PAST, & PRESENT

Did you know there was a National Law Enforcement Officers Memorial established in 1991?

It honors all of America's federal, state and local law enforcers. Inscribed on the Memorial's blue-gray marble walls are the names of more than 17,000 officers who have been killed in the line of duty, dating back to the first known death in 1792.

Designed by Washington, D.C. architect Davis Buckley, the Memorial sits on three acres of federal park land called Judiciary



Square. The site has served for some 200 years as the seat of our nation's judicial branch of government. A glance around the space finds plush carpets of grass, nearly 60,000 plants and 128 trees decorating the Memorial grounds. Each year, around the first of April, some 14,000 orange and yellow daffodils make the Memorial one of Washington's most spectacular attractions. Bordering the Memorial's beautifully landscaped park are two tree-lined "pathways of remembrance" where the names of the fallen officers are engraved.

Each of the pathway entrances are adorned with a powerful statuary of an adult lion protecting its cubs. The bronze statues were sculpted by Raymond Kaskey. They symbolize the protective role of our law officers and convey the strength, courage and valor that are the hallmarks of those who serve the law enforcement profession.

An inscription on the Memorial's east wall explains the uplifting spirit that is felt by every visitor to the Memorial: "In valor there is hope".

President George Bush, Sr. assisted in the dedication of the memorial in 1991. Mag was one of three original corporate sponsors to the Memorial Fund. John Wyatt, Vice President of Sales, attended the event on behalf of Mag and remarked at the time that, "Mag's contribution is our way of showing our gratitude for the support that Mag-Lite® flashlights have received from law enforcement officers across the nation." Mag has supplemented its initial commitment during the past ten years in order to help ensure that the men and women who have laid down their lives for our protection will never be forgotten.

THE FUTURE

Did you know there is going to be a National Law Enforcement Museum?

National Law Enforcement Officers Museum



Overview

In 2000, a law (P.L. 106-492) passed by the United States Congress and signed by President Clinton authorized a national law enforcement museum to be built on federal property in Washington, D.C. The museum will be privately funded and will be developed, constructed, owned and operated by the National Law Enforcement Officers Memorial Fund (NLEOMF) — the same nonprofit organization that built and now oversees the National Law Enforcement Officers Memorial. Construction is expected to commence in 2007. The museum opening is scheduled for 2009. The museum will reach a broad and diverse audience, with attendance expected to be as high as half a million visitors a year, including 40,000 students on class trips.

The Need

The need for a museum first became evident soon after the National Law Enforcement Officers Memorial was completed and there was a keen interest expressed by many visitors in learning the stories behind the thousands of officers memorialized. In 1993, a small Memorial Visitors Center was established near the monument. By 1997, the museum vision had grown and the NLEOMF decided to make the creation of a "Smithsonian-like law enforcement museum" its number one long-term objective. The museum's mission is to increase public support for law enforcement and to promote law enforcement safety.

Dating back to the first fatality in 1792, more than 17,000 officers have sacrificed their lives in the line of duty. Yet despite the dangers and other difficulties of the job, there are more than 800,000 federal, state and local law enforcement officers serving proudly today in communities across America, putting their lives on the line for the safety and protection of others. It is an incredible story of service and sacrifice that, for the most part, has gone untold. As a result, many Americans continue to take our police officers for granted. The National Law Enforcement Museum will help to generate a better understanding and appreciation of the vital contributions our law officers have made to our nation.

"Clearly, the courage and sacrifice displayed by our law enforcement officers is having a profound and positive effect on our society," declared Senator Ben "Nighthorse" Campbell after the museum legislation passed. Establishing this museum is the least we

can do to honor them and ensure that their stories of heroism and sacrifice are never forgotten."

The Site

The museum will be located in the heart of our Nation's Capital in a historic setting called Judiciary Square (400 block of E Street, NW). Appropriately, the museum site is directly across the street from the National Law Enforcement Officers Memorial, which was established in 1991. This property is surrounded by court buildings, the original City Hall for the District of Columbia, and the National Building Museum. This is a thriving area of downtown Washington that already attracts millions of tourists each year.

Maglite® Proud to help.

In the spirit of continuing Mag's commitment, Mag Instrument is now both a Founding Partner of the National Law Enforcement Museum and a Founding Member of the NLEOMF, and has been a Sterling Circle Member of the NLEOMF since 2002. For more information, please visit www.maglite.com.



National Fallen Firefighters Foundation



The United States Congress created the National Fallen Firefighters Foundation to lead a nationwide effort to remember America's fallen firefighters through a variety of activities. Since 1992, the tax-exempt, nonprofit foundation has developed and expanded programs to honor our fallen fire heroes and assist their families and coworkers.



Mag continues its tradition of philanthropy by donating \$25,000 to the National Fallen Firefighters Foundation (NFFF). The donated funds allow the survivors of fallen heroes to participate in such meaningful events as the Foundation's 2002 National Memorial Weekend in Washington, D.C.

Endorsed by



The Outfitters Association of America was designed to create a global organization of outfitters who are committed to providing a high quality outdoor experience through the use of natural resources while promoting responsible outdoor education. O.A.O.A. provides consumers with a source of dependable, trustworthy information on the top outfitters and guides in the world.



The new sponsorship relationship between Mag Instrument, Inc. and the Outfitters Association of America showcases a very proud commitment to the Outfitters and Guides who use our products. Mag-Lite®...The Professional Flashlight®.

Mag® Merchandise



Figure 1
Mag-Lite®
Cap - Black

Figure 1
Mag-Lite® Cap - Black

Embroidered (ASXXDE8)



Figure 2
Mag-Lite®
T-Shirt

Figure 2
Mag-Lite® T-Shirt

Silk Screened

	Black	White
Sm	ASXXDF8	ASXXDK8
Med	ASXXDG8	ASXXDL8
Lg	ASXXDH8	ASXXDM8
X-Lg	ASXXDI8	ASXXDN8
XX-Lg	ASXXDJ8	ASXXDO8



Figure 5
Mag-Lite®
Denim Shirt
Lightweight,
Long Sleeve

Figure 3
Mag-Lite® Denim Shirt
Lightweight,
Long Sleeve
Embroidered

Small	ASXXBI8
Medium	ASXXBJ8
Large	ASXXBK8
X-Large	ASXXBL8
XX-Large	ASXXAO8



Figure 4
Mag-Lite®
Polo Shirt

Figure 4
Mag-Lite® Polo Shirt
Embroidered

	Black	White
Sm	ASXXBY8	ASXXBU8
Med	ASXXCZ8	ASXXBV8
Lg	ASXXCA8	ASXXBW8
X-Lg	ASXXCB8	ASXXBX8
XX-Lg	ASXXAY8	ASXXAR8