

Metal halide lamp with quartz burner

HRI-TS 1000W/D/S/PRO/230/K12S

Radium

Product Datasheet Date: 21.03.2023

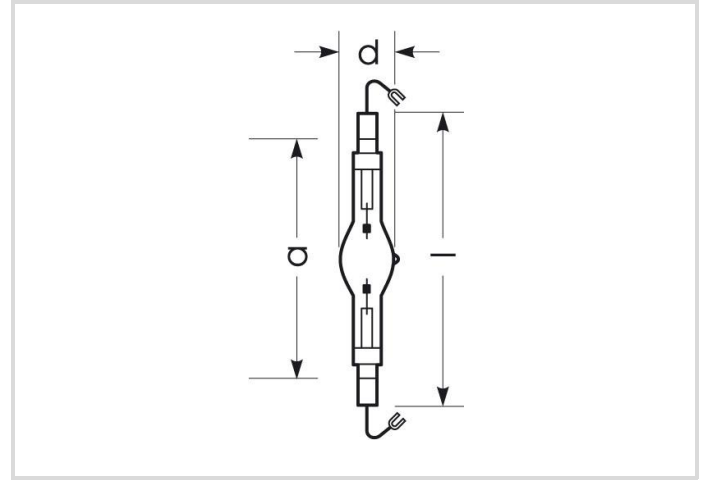

A+



90000



6100K



8 000h

General Data

| | |
|---------------------------|---|
| Article No. | 32416576 |
| Code | HRI-TS 1000W/D/S/PRO/230/K12S |
| Product EAN | 4008597165764 |
| Customs tariff no. | 85393290 |
| Box quantity (pcs.) | 10 |
| EAN Box | 4008597465765 |
| Gross weight of box in kg | 1.455 |
| Length of box in m | 0.385 |
| Width of box in m | 0.163 |
| Height of box in m | 0.258 |
| ETIM class | EC000037 |
| ETIM class name | Halogen metal halide lamp without reflector |
| Weight | 59 g |
| Product status | ● Active |

Electric Parameters

| | |
|----------------------|----------|
| Rated wattage | 1000.0 W |
| Lamp nominal wattage | 1 kW |

Electric Parameters

| | |
|---|---|
| Mains voltage | 230 V |
| Ignition voltage | 4.0 up to 5.0 |
| Hot restrike voltage | 36 kV |
| Lamp's nominal current | 9.3 A |
| Nominal choke current | 9.5 A |
| Compensation capacitor for 50Hz operation | 85 μ F |
| Running up current max. | 190% |
| Fuse | Delay-action; min. double nominal current |
| dimnable | No |
| Controllable (in suitable circuit) | No |

Light Application Parameters

| | |
|---------------------------------|----------|
| Luminous flux | 90000 lm |
| Rated lamp luminous flux | 90000 lm |
| Luminous efficiency | 90 lm/W |
| Radium light colour | daylight |
| Colour temperature | 6100 K |
| Color rendering index Ra | 85 |
| Rated colour rendering index Ra | 85 |
| Lumen maintenance at 2000h | 0.95 |
| Lumen maintenance at 4000h | 0.92 |
| Lumen maintenance at 6000h | 0.91 |
| Lumen maintenance at 8000h | 0.89 |
| Lumen maintenance at 12000h | 0.86 |
| Lumen maintenance at 16000h | 0.85 |
| Lumen maintenance at 20000h | 0.75 |

Service Life

| | |
|-------------------------------|--------|
| Average nominal lifespan | 8000 h |
| Lamp survival factor at 2000h | 0.99 |
| Lamp survival factor at 4000h | 0.97 |
| Lamp survival factor at 6000h | 0.90 |
| Lamp survival factor at 8000h | 0.50 |

Specification

| | |
|----------------------|-------------------------------|
| Energylabel notice | no Label needed (> 82.000 lm) |
| Energylabel A++ to E | A+ |
| Diameter | 36 mm |
| Length max. | 187 mm |
| Total length | 187 mm |
| Burning position | p15 / s15 |
| Mercury content | 75.0 mg |
| Model | Clear |
| Base | K12s-36 |
| Colour | White |

Notes on Operation

| | |
|------------------|-----------|
| Burning position | p15 / s15 |
|------------------|-----------|

Information especially for EPREL

| | |
|--------------------|-------------------------------|
| Energylabel notice | no Label needed (> 82.000 lm) |
|--------------------|-------------------------------|

Miscellaneous

| | |
|--------------|-----|
| EU Directive | TIM |
|--------------|-----|

Notes

Metal halide short arc lamp clear, daylight, high luminous flux, base K12s. Operation in enclosed luminaire, with ballast and (hot restrike)ignitor.

Please, refer to www.radium.de/recycling for notes on disposal of burned-out lamps as well as lamp breakage.

The "lifespan L70" described for LED lamps indicates the number of hours when the luminous flux has decreased to 70% of its initial value.

The optimal field 'info about service life' contains the frame conditions according to standards based on which the specific service life has been determined. So, for example, "12B50, 50Hz" means that the mean service life (B50) has been determined with a 12h switching cycle at mains (frequency 50Hz), "3B50, HF" is based on a 3h switching cycle at electronic control gear (high frequency).

Base



K12s-36
IEC/EN 60061-1
Sheet 7004-168-1

Spectrum

Natural daylight is a mixture of direct sunlight and the light of the sky. Therefore, its spectral composition changes permanently due to the changing time of day. The standardised light classification D65 corresponds to a daylight with a colour temperature of approximately 6500 K.

Every discharge lamp type has got an individual spectral power distribution according to its chemical filling. From this result important properties light colour or colour rendering.

Should the spectral lines be very close together the lamp presumably has got a very good colour rendering index, so, Ra might be near 100. Does the spectrum rather look like single lines or frayed out the colour rendering of the lamp will probably be not as good.

Metal halide lamp with quartz burner

HRI-TS 1000W/D/S/PRO/230/K12S

Radium

If number and height of the spectral lines within the blue range (around 400 nm) prevails it might be a lamp with a rather cold light colour like for example daylight. On the other hand, should the red (around 700 nm) or the red and yellow (around 600 nm) range be dominant one can assume that the lamp will be a rather warm light colour like WDL.

After the lamp start a metal halide lamp needs about 2-4 minutes time to reach its full luminous flux, all colours in the spectrum are within the discharge arc then.

Visible region from 380 to 780 nm; height of graph corresponding with relative spectral emission (400mW/klm) per 10nm.

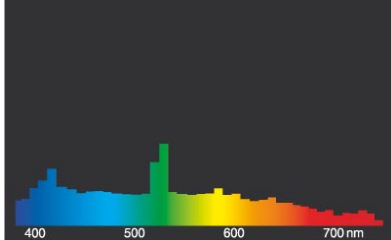

HRI.../D

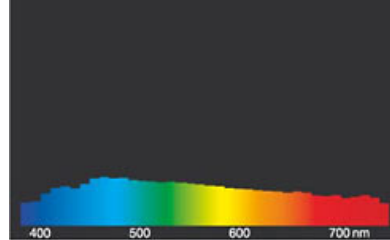

daylight(D 65)

Circuit diagram(s)

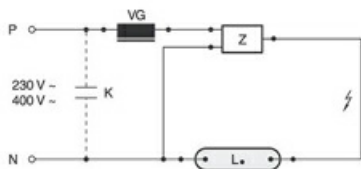

Standard circuit HID with external ignitor

Key:

L. = lamp

VG = electromagnetic ballast (KVG/VVG)

P = phase

N = zero potential

K = p. f. correction capacitor

Z = ignitor

The required control gear (here ignitor and ballast) for the lamps operation is usually mounted in the suitable luminaire in an appropriate electric circuit. Changes of any kind are to be conducted by qualified and specialised staff, only. Thus, this circuit example is to be understood merely as a technical background information for interested users.

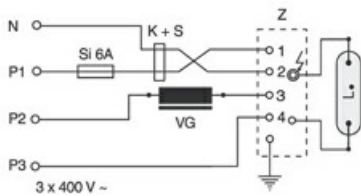

Circuit for 400V-HID-lamps suitable for hot restrike

Key:

L. = lamp

VG = electromagnetic ballast (KVG/VVG)

P = phase

N = zero potential

K = p. f. correction capacitor

Z = ignitor

S = fuse

The required control gear (here fuse, capacitor, ignitor and ballast) for the lamps operation is usually mounted in the suitable luminaire in an appropriate electric circuit. Changes of any kind are to be conducted by qualified and specialised staff, only. Thus, this circuit example is to be understood merely as a technical background information for interested users.

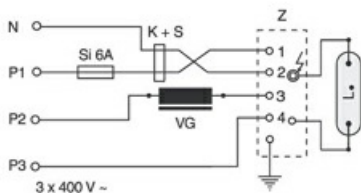

Circuit for 400V-HID-lamps suitable for hot restrike

Key:

L. = lamp

VG = electromagnetic ballast (KVG/VVG)

P = phase

N = zero potential

K = p. f. correction capacitor

Z = ignitor

S = fuse

The required control gear (here fuse, capacitor, ignitor and ballast) for the lamps operation is usually mounted in the suitable luminaire in an appropriate electric circuit. Changes of any kind are to be conducted by qualified and specialised staff, only. Thus, this circuit example is to be understood merely as a technical background information for interested users.

Metal halide lamp with quartz burner

HRI-TS 1000W/D/S/PRO/230/K12S

Radium

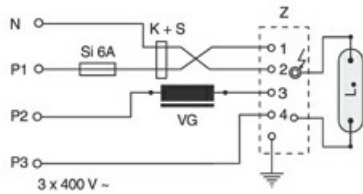

Circuit for 400V-HID-lamps suitable for hot restrike

Key:

L. = lamp

VG = electromagnetic ballast (KVG/VVG)

P = phase

N = zero potential

K = p. f. correction capacitor

Z = ignitor

S = fuse

The required control gear (here fuse, capacitor, ignitor and ballast) for the lamps operation is usually mounted in the suitable luminaire in an appropriate electric circuit. Changes of any kind are to be conducted by qualified and specialised staff, only. Thus, this circuit example is to be understood merely as a technical background information for interested users.

Special features



General notes

The technical design data in accordance with DIN and IEC. The producer does not take any responsibility for damage to persons or property in case of unsuitable operation or handling of the product. Operating data and dimensions are valid within the usual tolerances. Related lamp types (different bases, mains voltages) may be available on request. Sale and delivery are effected in accordance with the Radium Terms of Delivery and Payment valid on the day of conclusion of contract. Packing units offer economical advantages to the purchase and logistic department. Please match your quantity volume accordingly. For orders of a minimum quantity (clefts) with a lamp model the amount lower than the volume of each packaging unit, we will invoice 10 % additional charge per lamp type. Technical changes and terms of delivery are reserved. Manipulation of any kind to packaging or product is not permissible as this will violate Radium brand rights. Furthermore, technical properties of the product can change to its disadvantage or even destruction. Therefore, Radium cannot be responsible for consequential damages.

® = Registered trademark

Subject to change without notice. Errors and omissions excepted.

All technical data without guarantee.