

PAR56 and PAR64



PAR64 1000W 230V MFL

These self-contained spotlights are ideal for intensifying the visual experience in all kinds of clubs, that is because their accurate beam control picks out even the smallest of details even over long distances. This beam control makes the PAR 56 and PAR 64 excellent for long-range light projections. In addition, the universal burning feature provides complete flexibility of luminaires angle and position, while the front glass of the PAR56 provides thermal and physical protection. The result? Complete creative freedom to achieve the desired effect. Immediate re-strike also ensures instant resumption of entertainment after any power interruption.

Product data

• General Characteristics

ANSI Code	EXE
LIF Code	CP62
Cap-Base	GX16d
Cap-Base Information	-
Bulb	PAR64 [PAR 64inch/180mm]
Operating Position	any
Main Application	Flood and Ambient Lighting
Gas Filling	GAS
Average Lifetime	300 hr
Life to 50% failures	300 (min) hr

• Light Technical Characteristics

Beam Description	Medium Flood
Beam Angle	23 D
Beam Angle Technical	23 D
Luminous Intensity	130000 (max) cd
Color Temperature	3200 K

• Electrical Characteristics

Lamp Wattage	1000 W
--------------	--------

Voltage	230 V
Dimmable	Yes

• Product Dimensions

Overall Length C	150 (max) mm
Diameter D	204 (max) mm

• Product Data

Order code	924783444204
Full product code	924783444204
Full product name	PAR64 1000W 230V MFL
Order product name	PAR64 1000W 230V MFL
Pieces per pack	1
Packing configuration	6
Packs per outerbox	6
Bar code on pack - EAN1	8711500440891
Bar code on outerbox - EAN3	8711500440907
Logistic code(s) - 12NC	924783444204
Net weight per piece	0.760 kg

PHILIPS

Dimensional drawing

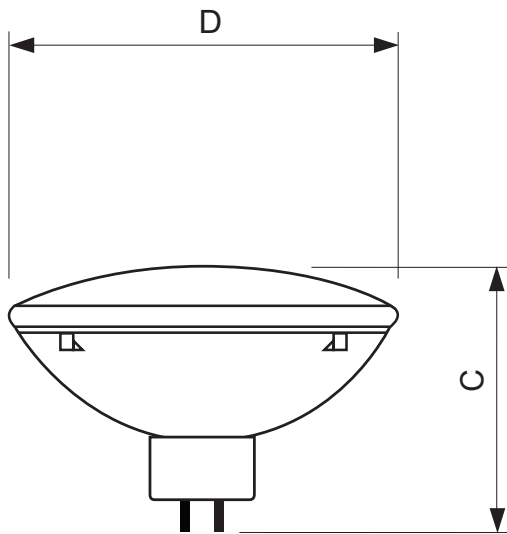

PAR64 1000W 230V MFL

Product	C (Max)	D (Max)
PAR64 1000W 230V MFL	150	204



© 2013 Koninklijke Philips N.V. (Royal Philips)
All rights reserved.

Specifications are subject to change without notice. Trademarks are the property of Koninklijke Philips N.V. (Royal Philips) or their respective owners.

www.philips.com/lighting

2013, October 31
data subject to change