

PHILIPS

Xitanium

LED driver

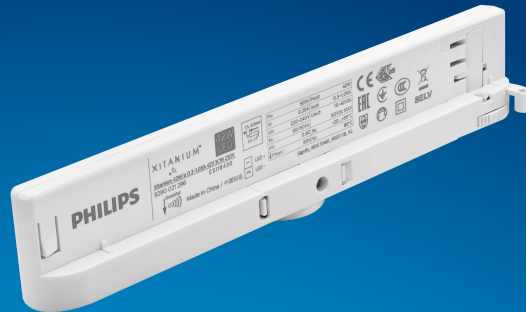

Datasheet

Xitanium track adaptor drivers (3C)

Xitanium 20W/a 0.15-0.5A 42V 3CW 230V

9290 021 29306

Affordable and reliable LED Drivers

Affordable LED driver range offering Philips reliability. The Xitanium track driver range is compatible with COB and mid-power LEDs from any LED manufacturer.

Benefits

- Driver design based on Philips experience and knowledge of conventional fluorescent and HID technologies
- Various power ratings matching common lumen packages/applications
- Track adaptor housing design for compact track luminaire designs

Features

- Compact size
- Specific, optimized dual-output current choice
- Long lifetime
- Low output current ripple, low input current THD
- Suitable for 3-phase track systems
- Available in white, black and grey housing color

Application

- Public buildings (airports, cinemas, theaters, exhibition halls)
- Retail (supermarkets, shops)
- Offices

Electrical input data

Specification item	Value	Unit	Condition
Rated input voltage range	220...240	V _{ac}	Performance range
Rated input voltage	230	V _{ac}	
Rated input frequency range	50...60	Hz	Performance range
Rated input current	0.11	A	@ full output power @ rated input voltage
Max. input current	0.12	A	@ rated output power @ minimum performance input voltage
Rated input power	50	W	@ rated output power @ rated input voltage
Power factor	0.9		@ full output power @ rated input voltage
Total harmonic distortion	20	%	@ rated output power @ rated input voltage
Efficiency	85	%	@ 230V full load
Input voltage AC range	202...254	V _{ac}	Safety operational range
Input frequency AC range	47.5...63	Hz	Safety operational range
Isolation input to output	SELV		

Electrical output data

Specification item	Value	Unit	Condition
Regulation method	Constant Current		
Output voltage	10...42	V _{dc}	
Output voltage max.	60	V	Maximum output voltage (rms)
Output current	0.15...0.5	A	
Output current tolerance ±	5	%	
Output current ripple LF	≤ 4	%	Ripple = peak / average, < 3kHz
Output power	5...20	W	

Electrical data controls input

Specification item	Value	Unit	Condition
Control method	Fixed		Set output current via SimpleSet (AOC)

Wiring and Connections

Specification item	Value	Unit	Type
Output wire cross-section	0.5...1.5 / 20...16	mm ² / AWG	Changhong250, solid / stranded wire
Output wire strip length	7.5...8.5	mm	
Maximum cable length	0.3	m	Total length of wiring including LED module, one way

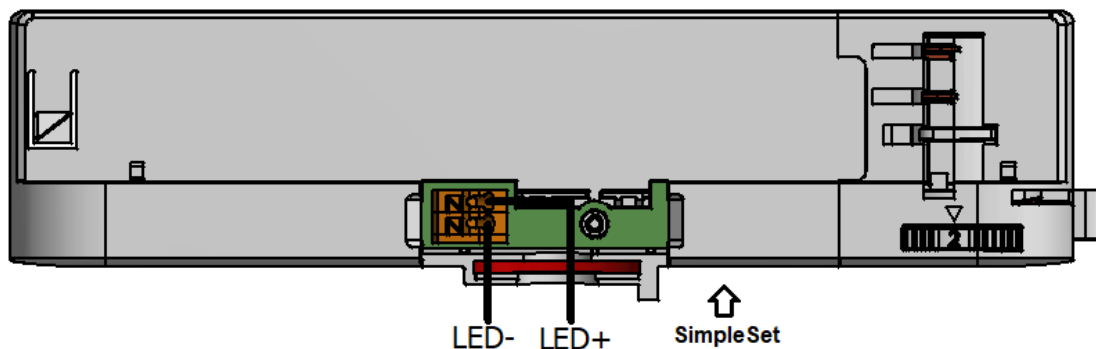

Insulation

Insulation per IEC61347-1	Input	Output
Input		SELV
Output	SELV	

Dimensions and weight

Specification item	Value	Unit	Tolerance (mm)
Length (A1)	171	mm	
Mounting hole distance (A2)	88	mm	
Width (B1)	31	mm	
Width (B2)	13.2	mm	
Height (C1)	43.8	mm	
Height (C2)	13.7	mm	
Mounting hole diameter (D1)	27.3	mm	
Mounting hole diameter (D2)	24.4	mm	
Weight	108	gram	
Housing color	White (RAL 9003)		

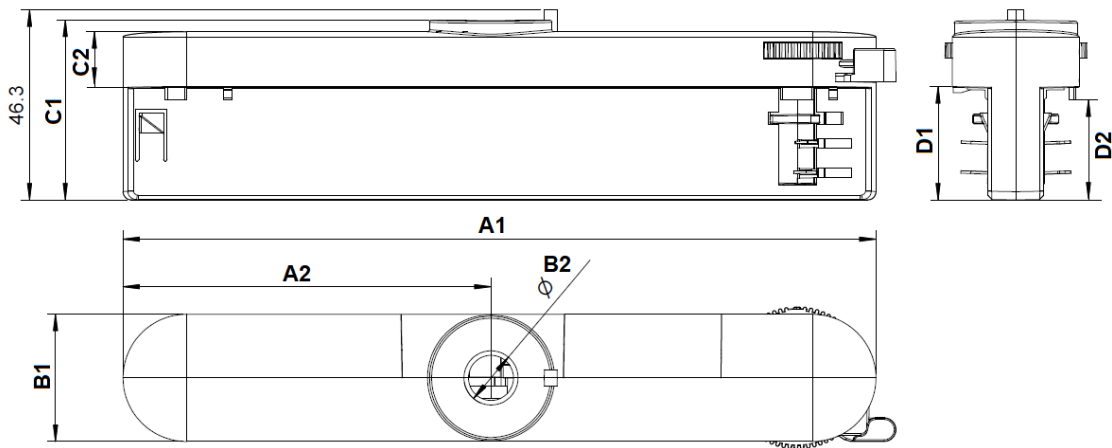

Logistical data

Specification item	Value
Product name	Xitanium 20W/a 0.15-0.5A 42V 3CW 230V
EOC	871869973466400
Logistic code 12NC	9290 021 29306
EAN1 (GTIN)	8718699734664
EAN3	8718699734671
Pieces per box	40

Operational temperatures and humidity

Specification item	Value	Unit	Condition
Ambient temperature	-20...+35	°C	Higher ambient temperature allowed as long as T _{case-max} is not exceeded
T _{case-max}	85	°C	Maximum temperature measured at T _{case-point}
T _{case-life}	85	°C	Measured at T _{case-point}
Maximum housing temperature	130	°C	In case of a failure, inherent by design
Relative humidity	10...90	%	Non-condensing

Lifetime

Specification item	Value	Unit	Condition
Driver lifetime	50,000	hours	Measured temperature at Tcase-point is Tcase-life. Maximum failures = 10%

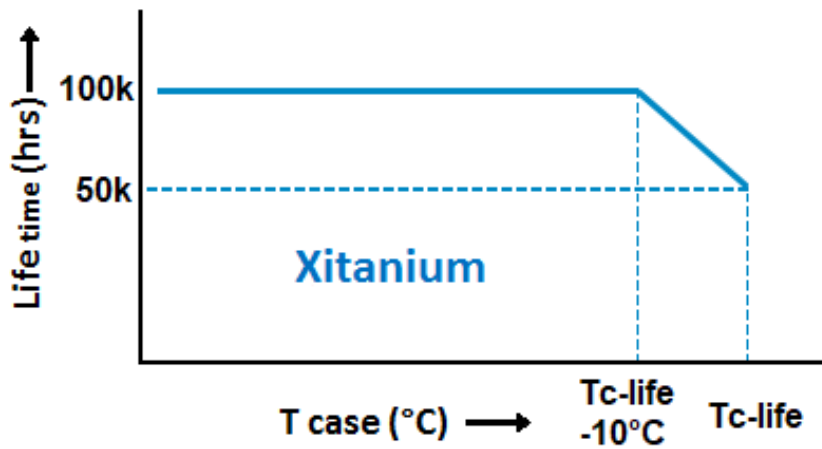

Storage temperature and humidity

Specification item	Value	Unit	Condition
Ambient temperature	-25...+85	°C	
Relative humidity	5...95	%	Non-condensing

Programmable features

Specification item	Available	Default setting	Condition
Set Adjustable Output Current (AOC)	SimpleSet	150 mA	
OEM Write Protection (OWP)	Yes	OFF	
Luminaire Info	Yes	—	

Features

Specification item	Value	Condition
Open load protection	Yes	Automatic recovering
Short circuit protection	Yes	Automatic recovering
Over power protection	Yes	Automatic recovering
Hot wiring	No	
Suitable for fixtures with protection class	I	per IEC60598

Inrush current

Specification item	Value	Unit	Condition
Inrush current I_{peak}	8	A	Input voltage 230V
Inrush current T_{width}	150	μ s	Input voltage 230V, measured at 50% I_{peak}
Drivers / MCB 16A type B	≤ 72	pcs	Indicative value



MCB	Rating	Relative number of LED drivers
B	4A	25%
B	6A	40%
B	10A	63%
B	13A	81%
B	16A	100% (stated in datasheet)
B	20A	125%
B	25A	156%
B	32A	200%
B	40A	250%
C	4A	42%
C	6A	63%
C	10A	104%
C	13A	135%
C	16A	170%
C	20A	208%
C	25A	260%
C	32A	340%
C	40A	415%

Driver touch current / protective conductor current

Specification item	Value	Unit	Condition
Typical Touch Current (ins. Class II)	0.7	mA peak	Acc. IEC61347-1. LED module contribution not included

Surge immunity

Specification item	Value	Unit	Condition
Mains surge immunity (diff. mode)	1	kV	Acc. IEC61000-4-5. 2 Ohm, 1.2/50us, 8/20us
Mains surge immunity (comm. mode)	2	kV	Acc. IEC61000-4-5. 12 Ohm, 1.2/50us, 8/20us

Application Info

Specification item	Value
Approval marks	CE / CQC / EAC / ENEC / RCM / SELV / UA
Ingress Protection classification (IP)	20
Application	Indoor Point
Mounting Type	Track mounting

Graphs

Operating window

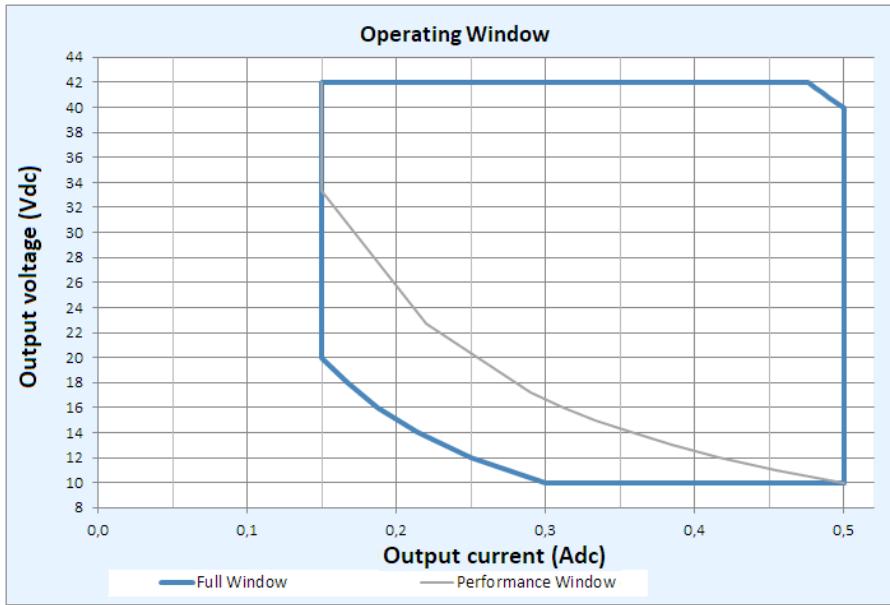

Power factor versus output power

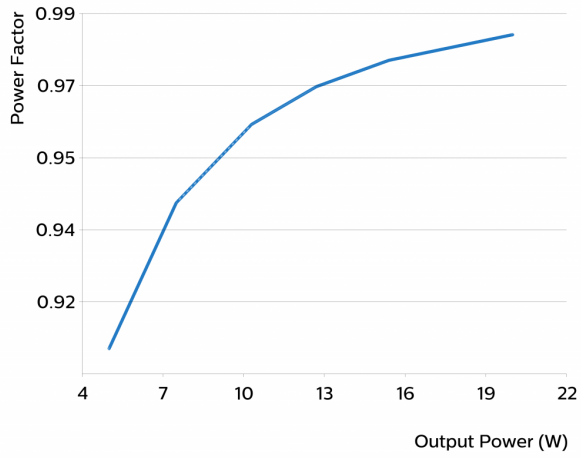

Efficiency versus output power

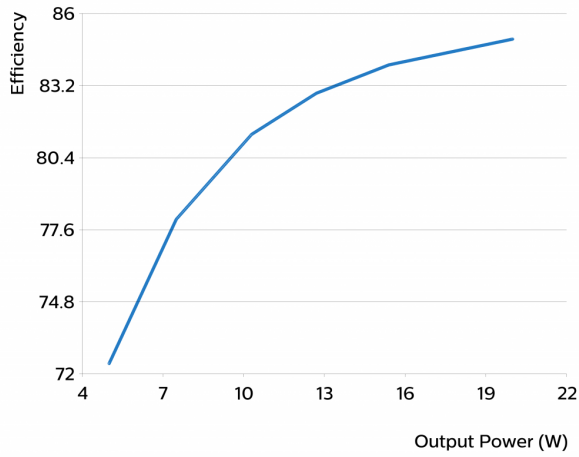

THD versus output power

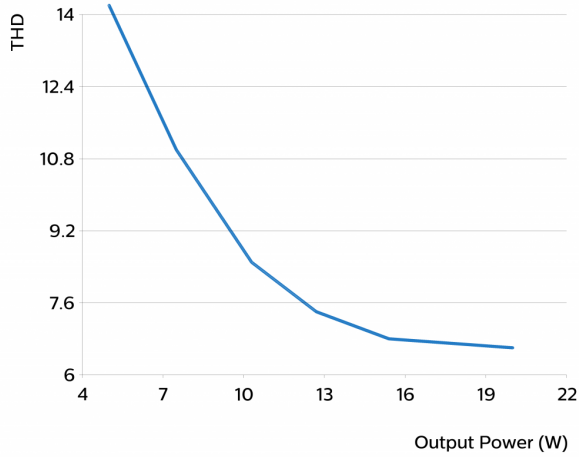

Notes

The adapter is compatible with Global Trac Pro, Stucchi OneTrack 3 Circuit tracks.



©2021 Signify Holding, IBRS 10461, 5600 VB, NL. All rights reserved.
UK importer address: Signify Commercial UK Limited, 3, Guildford Business Park, GU2 8XG.

The information provided herein is subject to change without notice. Signify does not give any representation or warranty as to the accuracy or completeness of the information included herein and shall not be liable for any action in reliance thereon. The information presented in this document is not intended as any commercial offer and does not form part of any quotation or contract, unless otherwise agreed by Signify.

Philips and the Philips Shield Emblem are registered trademarks of Koninklijke Philips N.V. All other trademarks are owned by Signify Holding or their respective owners.

Date of release: January 14, 2021 v2

www.philips.com/oem