

# PHILIPS

## Xitanium

### LED driver

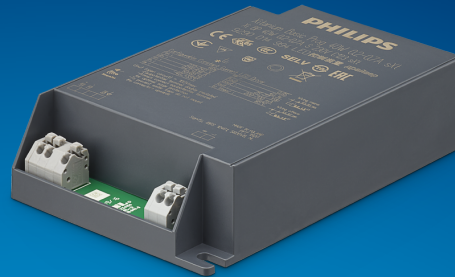

## Datasheet

### Xitanium Basic Prog LED Outdoor drivers

Xi BP 40W 0.2-0.7A S 230V C123 sXt

9290 014 99406

#### Xitanium Basic Prog LED Outdoor drivers

Philips Xitanium Basic Programmable LED drivers are offering a basic feature set and high performance, making it a preferred choice for various outdoor applications. The portfolio offers flexibility with a customizable operating window, enabling differentiation in LED lighting designs via system tuning and being prepared for LED efficacy upgrades. In this product family Philips offers drivers in compact form factors with a basic feature set, which offer high value for both OEM customers and end-users. The key features AOC (Adjustable Output Current) and OWP (Over Write Protection) are programmable via SimpleSet<sup>®</sup>, an easy and fast way to configure the driver without the need to power the driver. A great combination with MultiOne Basic configuration software. The products can replace the existing single current outdoor LED drivers and will bring significant improvement in programming, assembly into a luminaire, electrical performance, and less variety in logistical codes.

#### Benefits

- Outdoor robustness, offering peace of mind and lower maintenance costs
- Basic configurable features covering many applications
- Easy to design-in and install for Insulation Class I and Class II applications
- Enabling integration in small(er) size luminaires due to compact form factor(s)

#### Features

- SimpleSet<sup>®</sup>, wireless configuration interface
- High surge immunity
- Long lifetime and robust protection against moisture, vibration and temperature
- Configurable operating window (AOC)
- Over Write Protection (OWP)

#### Application

- Road and street lighting
- Park lighting (e.g. BP 12W driver for bollards, landscape fixture, wall mounts)
- Residential lighting
- Architectural lighting

## Electrical input data

Specification item	Value	Unit	Condition
Rated input voltage range	202...254	V <sub>ac</sub>	Performance range
Rated input voltage	230	V <sub>ac</sub>	
Rated input frequency range	47...63	Hz	Performance range
Rated input current	0.19	A	@ rated output power @ rated input voltage
Max. input current	0.23	A	@ rated output power @ minimum performance input voltage
Rated input power	46	W	@ rated output power @ rated input voltage
Power factor	0.98		@ rated output power @ rated input voltage
Total harmonic distortion	9	%	@ rated output power @ rated input voltage
Efficiency	90	%	@ rated output power @ rated input voltage @ AOC = 300mA
Input voltage AC range	80...264	V <sub>ac</sub>	Safety operational range
Input frequency AC range	45...66	Hz	Safety operational range
Isolation input to output	SELV		

## Electrical output data

Specification item	Value	Unit	Condition
Regulation method	Constant Current		
Output voltage	25...77	V <sub>dc</sub>	
Output voltage max.	100	V	Maximum voltage at open load
Output current	0.2...0.7	A	
Output current min programmable	200	mA	
Output current tolerance ±	5	%	
Output current ripple LF	≤ 4	%	Ripple = peak / average @ 3kHz
Output current ripple HF	≤ 4	%	
Output P <sub>st</sub> <sup>LM</sup>	≤ 0.2		
Output SVM	≤ 0.08		
Output power	5...40	W	

## Electrical data controls input

Specification item	Value	Unit	Condition
Control method	Fixed		

## Wiring and Connections

Specification item	Value	Unit	Type
Input wire cross-section	0.5...1.5 / 20...16	mm <sup>2</sup> / AWG	WAGO250 (pitch 3.5 mm), solid / stranded wire
Input wire strip length	8.5...9.5	mm	
Output wire cross-section	0.5...1.5 / 20...16	mm <sup>2</sup> / AWG	WAGO250 (pitch 3.5 mm), solid / stranded wire
Output wire strip length	8.5...9.5	mm	
Maximum cable length	1.5	m	Total length of wiring including LED module, one way

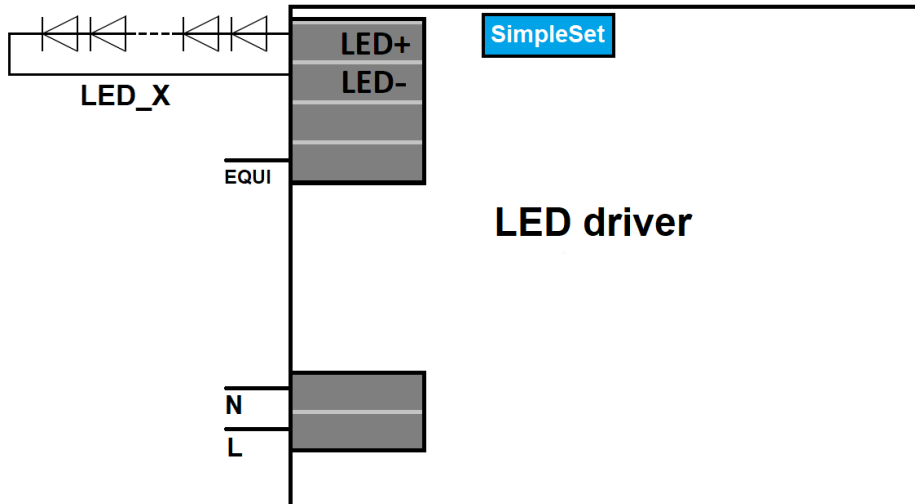

## Insulation

Insulation per IEC61347-1	Mains	EQUI	LED
Mains		SELV	
EQUI	Basic		
LED	SELV	Basic	

## Dimensions and weight

Specification item	Value	Unit	Tolerance (mm)
Length (A1)	123	mm	
Mounting hole distance (A2)	111	mm	
Width (B1)	79	mm	
Width (B2)	67	mm	
Height (C1)	31	mm	
Mounting hole diameter (D1)	4.5	mm	
Weight	190	gram	

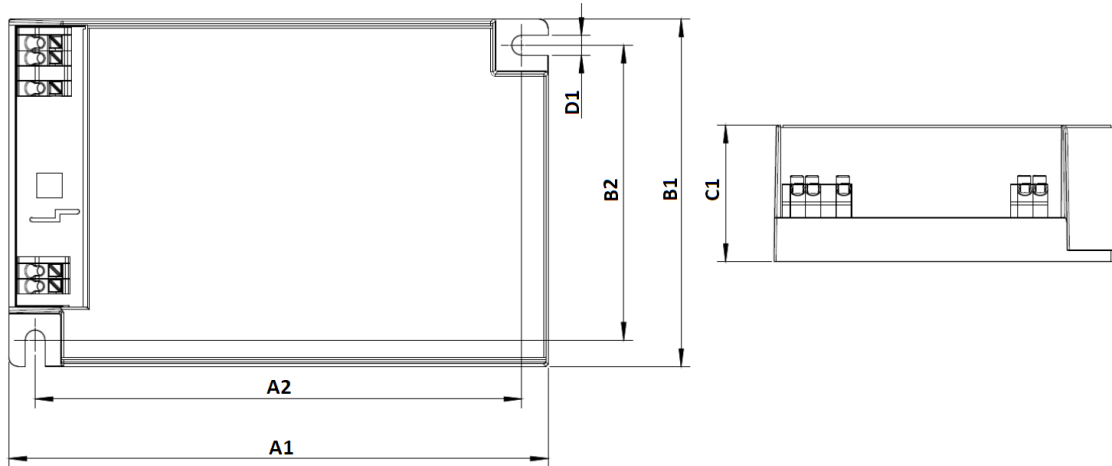

## Logistical data

Specification item	Value
Product name	Xi BP 40W 0.2-0.7A S 230V C123 sXt
EOC	871869967027600
Logistic code 12NC	9290 014 99406
EAN1 (GTIN)	8718699670276
EAN3	8718699670283
Pieces per box	20

## Operational temperatures and humidity

Specification item	Value	Unit	Condition
Ambient temperature	-40...+55	°C	Higher ambient temperature allowed as long as T <sub>case-max</sub> is not exceeded
T <sub>case-max</sub>	85	°C	Maximum temperature measured at T <sub>case-point</sub>
T <sub>case-life</sub>	75	°C	Measured at T <sub>case-point</sub>
Maximum housing temperature	120	°C	In case of a failure, inherent by design
Relative humidity	10...90	%	Non-condensing

## Lifetime

Specification item	Value	Unit	Condition
Driver lifetime	100,000	hours	Measured temperature at Tcase-point is Tcase-life. Maximum failures = 10%

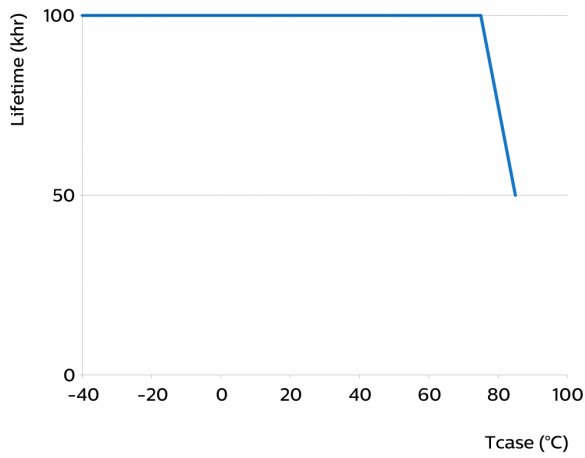

## Storage temperature and humidity

Specification item	Value	Unit	Condition
Ambient temperature	-40...+85	°C	
Relative humidity	5...95	%	Non-condensing

## Programmable features

Specification item	Available	Default setting	Condition
Set Adjustable Output Current (AOC)	SimpleSet	700 mA	
OEM Write Protection (OWP)	Yes	OFF	

## Features

Specification item	Value	Condition
Open load protection	Yes	Automatic recovering
Short circuit protection	Yes	Automatic recovering
Over power protection	Yes	Automatic recovering
Hot wiring	No	
Suitable for fixtures with protection class	I and II	per IEC60598
Overtemperature protection	Yes	Automatic recovering

## Inrush current

Specification item	Value	Unit	Condition
Inrush current $I_{peak}$	19	A	Input voltage 230V
Inrush current $T_{width}$	210	$\mu$ s	Input voltage 230V, measured at 50% $I_{peak}$
Drivers / MCB 16A type B	$\leq 32$	pcs	Indicative value

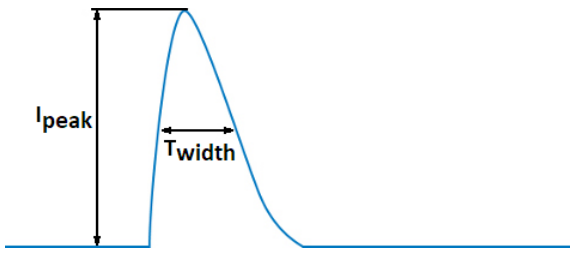

MCB	Rating	Relative number of LED drivers
B	4A	25%
B	6A	40%
B	10A	63%
B	13A	81%
B	16A	100% (stated in datasheet)
B	20A	125%
B	25A	156%
B	32A	200%
B	40A	250%
C	4A	42%
C	6A	63%
C	10A	104%
C	13A	135%
C	16A	170%
C	20A	208%
C	25A	260%
C	32A	340%
C	40A	415%

## Driver touch current / protective conductor current

Specification item	Value	Unit	Condition
Typical Touch Current (ins. Class II)	0.27	mA peak	Acc. IEC61347-1. LED module contribution not included
Typical Protective Conductor Current (ins. Class I)	0.2	mA rms	Acc. IEC60598-1. LED module contribution not included

## Surge immunity

Specification item	Value	Unit	Condition
Mains surge immunity (diff. mode)	6	kV	L-N acc. IEC61000-4-5. 2 Ohm, 1.2/50us, 8/20us
Mains surge immunity (comm. mode)	10	kV	L/N - EQUI: acc. IEC61000-4-5. 12 Ohm, 1.2/50us, 8/20us

## Application Info

Specification item	Value
Approval marks	CB / CCC / CE / EAC / ENEC / SELV / UA
Ingress Protection classification (IP)	20
Application	Outdoor
Mounting Type	Built-in

## Graphs

### Operating window

---

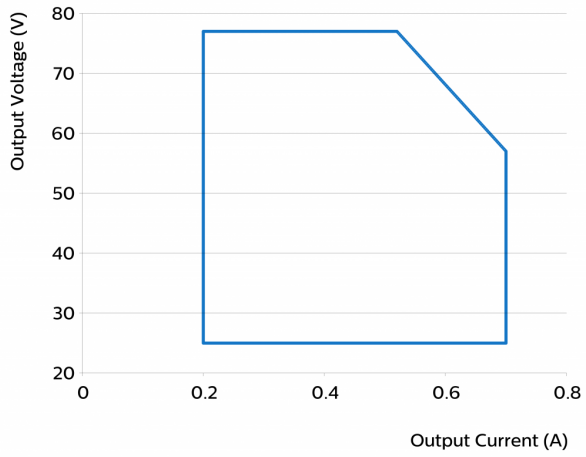

### Thermal Guard

---

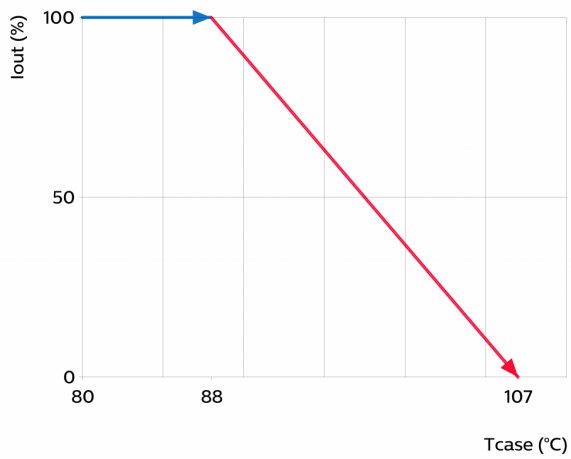

### Mains Guard

---

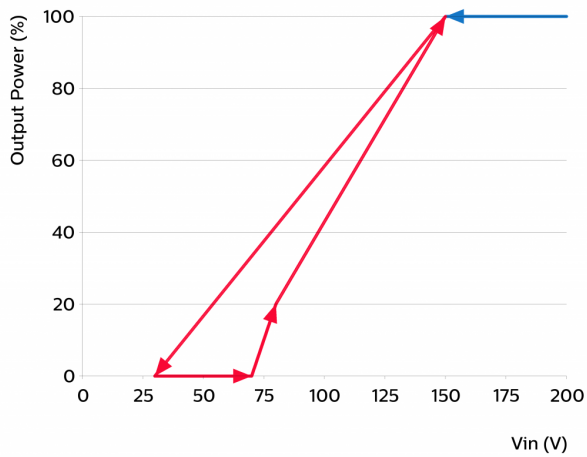

### Power factor versus output power

---

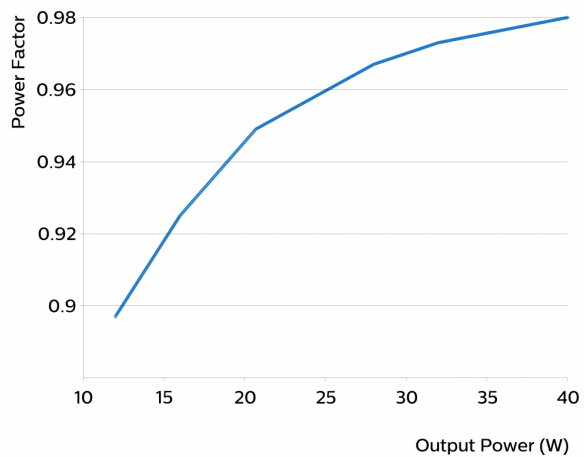

### Efficiency versus output power

---

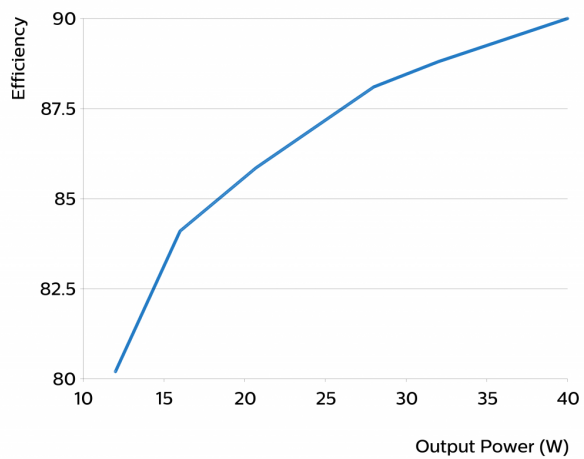

### THD versus output power

---

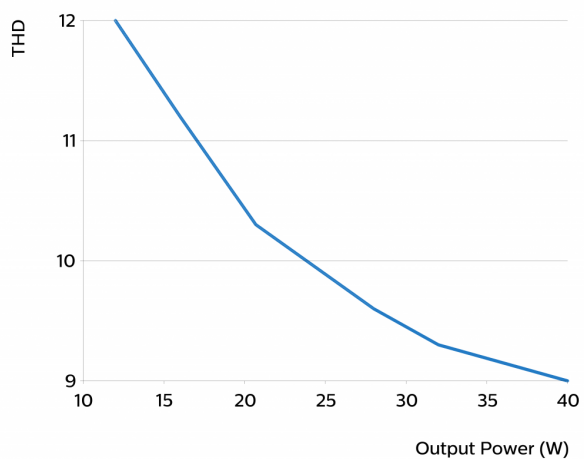





©2021 Signify Holding, IBRS 10461, 5600 VB, NL. All rights reserved.  
UK importer address: Signify Commercial UK Limited, 3, Guildford Business Park, GU2 8XG.

The information provided herein is subject to change without notice. Signify does not give any representation or warranty as to the accuracy or completeness of the information included herein and shall not be liable for any action in reliance thereon. The information presented in this document is not intended as any commercial offer and does not form part of any quotation or contract, unless otherwise agreed by Signify.

Philips and the Philips Shield Emblem are registered trademarks of Koninklijke Philips N.V. All other trademarks are owned by Signify Holding or their respective owners.

Date of release: February 3, 2021 v2

[www.philips.com/oem](http://www.philips.com/oem)