



MASTER LEDtube EM/ Mains T8

Master LEDTube 1200 mm 18W 865 T8 I W

The Philips MASTER LEDtube integrates a LED light source into a traditional fluorescent form factor. Its unique design creates a perfectly uniform visual appearance which cannot be distinguished from traditional fluorescent. For those that are looking for value for money within limited budget and re-lamping efforts for better light effect and lifetime.

Warnings and Safety

- NOTE: The overall energy efficiency and light distribution of any installation that uses these lamps will be determined by the design of the installation.

Product data

General information		LLMF At End Of Nominal Lifetime (Nom) 70 %	
Cap-Base	G13 [Medium Bi-Pin Fluorescent]	Operating and electrical	
EU RoHS compliant	Yes	Input Frequency	50 to 60 Hz
Nominal Lifetime (Nom)	50000 h	Power (Nom)	18 W
Switching Cycle	50000X	Lamp Current (Max)	210 mA
Light technical		Lamp Current (Min)	74 mA
Color Code	865 [CCT of 6500K]	Starting Time (Nom)	0.5 s
Beam Angle (Nom)	160 °	Warm Up Time to 60% Light (Nom)	0.5 s
Luminous Flux (Nom)	2100 lm	Power Factor (Nom)	0.92
Color Designation	Cool Daylight	Voltage (Nom)	100-240 V
Correlated Color Temperature (Nom)	6500 K	Temperature	
Luminous Efficacy (rated) (Nom)	116.00 lm/W	T-Ambient (Max)	45 °C
Color Consistency	<6	T-Ambient (Min)	-20 °C
Color Rendering Index (Nom)	82	T-Storage (Max)	65 °C

MASTER LEDtube EM/Mains T8

T-Storage (Min)	-40 °C
T-Case Maximum (Nom)	55 °C

Controls and dimming

Dimmable	No
----------	----

Mechanical and housing

Product Length	1200 mm
Bulb Shape	Tube, double-ended

Approval and application

Energy Saving Product	Yes
Suitable For Accent Lighting	No
Approval Marks	RoHS compliance CE marking KEMA Keur certificate

Energy Consumption kWh/1000 h	18 kWh
-------------------------------	--------

Product data

Full product code	871869969524800
Order product name	Master LEDTube 1200 mm 18W 865 T8 I W
EAN/UPC - Product	8718699695248
Order code	929001187882
Numerator - Quantity Per Pack	1
Numerator - Packs per outer box	10
Material Nr. (12NC)	929001187882
Net Weight (Piece)	0.215 kg

Dimensional drawing

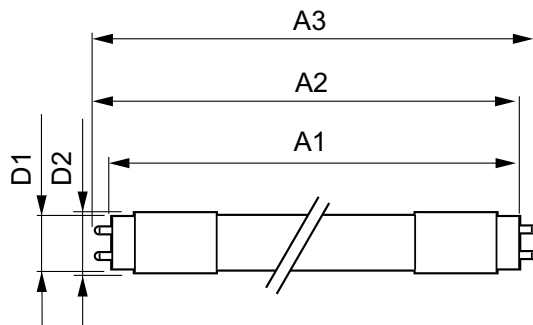

Master LEDTube 1200 mm 18W 865 T8 I W

Product	D1	D2	A1	A2	A3
Master LEDTube 1200 mm 18W 865 T8 I W	25.6 mm	27.8 mm	1198.1 mm	1205.2 mm	1212.3 mm

Photometric data

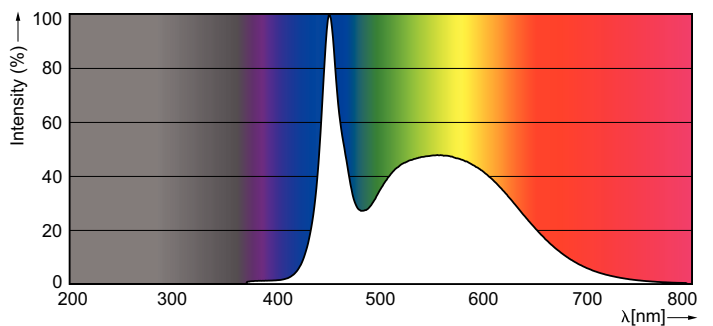
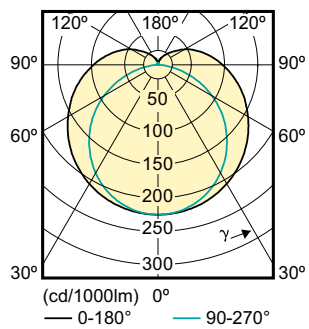

SDPO_MLEDGA_0069-Spectral Power distribution

MASTER LEDtube EM/Mains T8

Lifetime

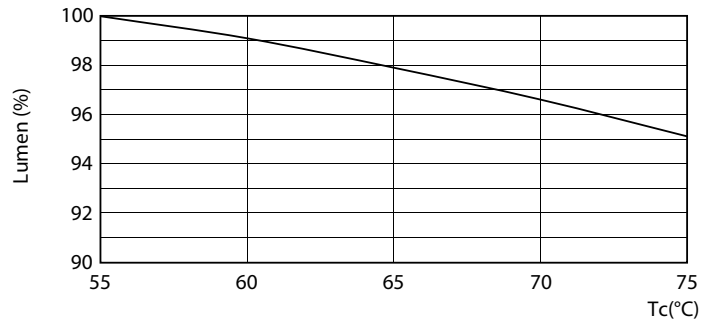
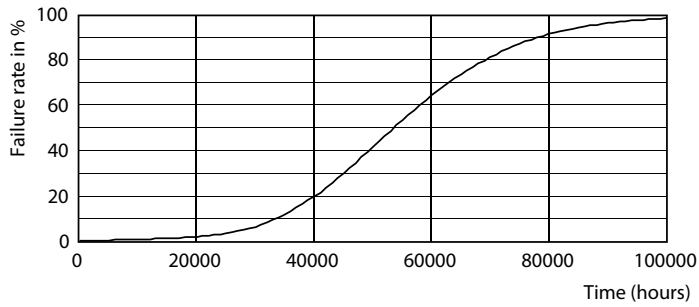

LEDTube 1200 mm 18W 840 T8 I W

LEDTube 1200 mm 18W 840 T8 I W LumenVsTc

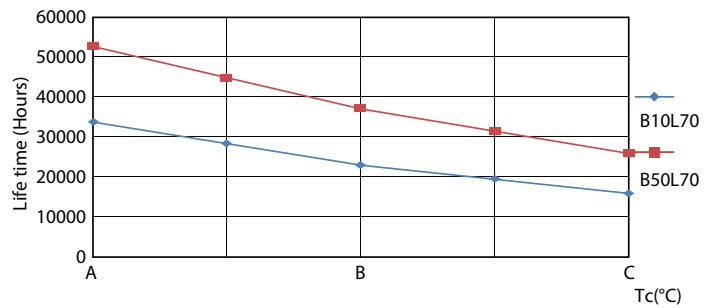
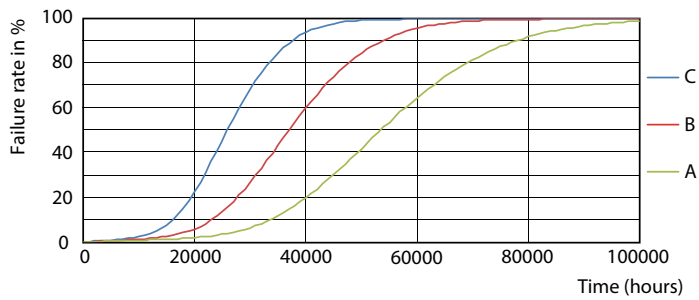

LEDTube 1200 mm 18W 840 T8 I W FailureRate

LEDTube 1200 mm 18W 840 T8 I W LifetimeVsTc

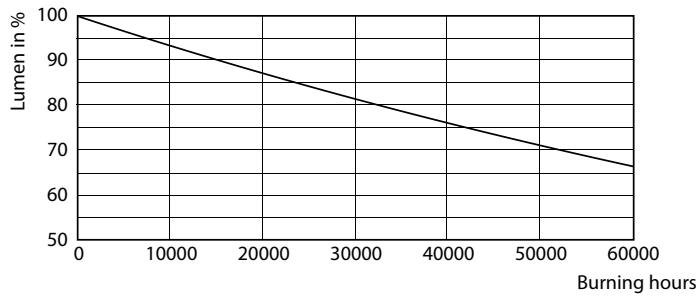

LEDTube 1200 mm 18W 840 T8 I W

MASTER LEDtube EM/Mains T8

