

HF-Performer II for PL-T/C/R/L/TL5C lamps

HF-Performer 1 22-42 PL-T/C/L/TL5C EII 220-240V



HF-Performer EII PL-T/C/R/T5c is a sustainable, slim and high-frequency electronic ballast for a wide range of CFL- ni applications. It is ideal for applications where high energy efficiency is required. The HF-Performer EII range has a robust design, meets all relevant international safety and performance standards and is energy-efficient (CELMA EEI A2).

Product data

• General Characteristics

Application code	EII
Rated Lamptype	PL-T/C/L/TL5C
Rated Number of Lamps	1 piece
Rated Ballast-Lamp Power	22-42
Line Voltage	220-240 V
Line Frequency	50/60 Hz
Energy Efficiency Index	A2
Lifetime 90% surv.@Tcaselife	50000 hr
Ignition Method	Warm Start

• Operating Characteristics

Automatic restart	Yes
Ignition time	0.52 (max) s
Operating frequency	42 (min), 45 (nom) kHz
Mains voltage safety (AC)	-10%/+10%
Mains voltage performance (AC)	-8%/+6%
Inrush current Peak	18 (max) A
Inrush current Width	0.25 ms
Earth leakage current	0.5 mA
Power losses gear	2.86-2.66 W
Constant wattage deviation	-2%/+2%
Ballast Lumen Factor	1 -
PowerFactor 100% output power	0.95 -
Battery voltage lamp ignition	198-254 V
Battery voltage running lamps	176-254

Overvoltage protection 320Vac	48 hr
Overvoltage protection 350Vac	2 hr
Max ballast on MCB(16A type B)	28 x
Crestfactor	1.7 (max) -
Hum and Noise level	Inaudible
Total Harmonic Distortion EUR	17 %

• Wiring Characteristics

Cable-Cap output-wires to earth	200 pF
Cable-Cap output-wires mutual	200 pF
Conn.type input terminals	Insert
Conn.type output terminals	Insert
Max. cable length	0.75 m
Hot Wires	
Striplength	7.5-8.5 mm
Dual fixture Master/Slave	Not applicable [Master/Slave oper. not applicable]
Wcs Input terminals	0.50-1.50 mm ²
Wcs Output terminals	0.50-1.50 mm ²

• System Chars on driver level

Rated Lamp Power on PL-T/C	22/42
----------------------------	-------



asimpleswitch.com

PHILIPS

HF-Performer II for PL-T/C/R/L/TL5C lamps

• Temperature Characteristics

T-case life	75 C
T-case maximum	75 (max) C
T-ignition	-25 (min), 50 (max) C
T-ambient	-25 (min), 50 (max) C
T-storage	-40 (min), 80 (max) C

• Product Dimensions

Length A1	103.0 mm
Fixing Hole Distance	93.5 mm
Length A2	
Width B1	67.0 mm
Fixing Hole Distance	57.5 mm
Width B2	
Height C1	30.0 mm
Fixing Hole Diameter	4.5 mm
D1	

• Approval & Application Chars

EMI 9kHz .. 30 MHz	EN 55015
EMI 30 MHz .. 1000MHz	EN 55022 level B [Level = Class]
Safety Standard	IEC 61347-2-3
Performance Standard	IEC 60929
Quality Standard	ISO 9000:2000
Environmental Standard	ISO 14001

Harmonic current emissions	IEC 61000-3-2
EMC Immunity	IEC 61547
Vibrations	IEC 68-2-6 Fc
Bumps	IEC 68-2-29 Eb
Humidity	EN 61347-2-3 clause 11
Approval marks	ENEC / VDE-EMV
CE marking	Yes
Temperature marking	110 [Yes]
Emergency standard	IEC 60598-2-22

• Product Data

Order code	913700630766
Full product code	913700630766
Full product name	HF-P 1 22-42 PL-T/C/L/TL5C EII 220-240V
Order product name	HF-P 1 22-42 PL-T/C/L/TL5C EII 220-240V
Pieces per pack	1
Packing configuration	12
Packs per outerbox	12
Bar code on pack - EAN1	8711500913975
Bar code on outerbox - EAN3	8711500913982
Logistic code(s) - 12NC	913700630766
Net weight per piece	0.140 kg

Dimensional drawing

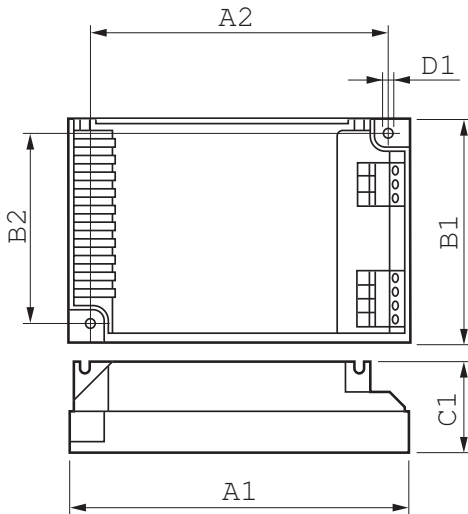

HF-Performer 1 22-42 PL-T/C/L/TL5C EII 220-240V

Product	A1 (Norm)	A2 (Norm)	B1 (Norm)	B2 (Norm)	C1 (Norm)	D1 (Norm)
HF-P 1 22-42 PL-T/C/L/TL5C EII 220-240V	103.0	93.5	67.0	57.5	30.0	4.5

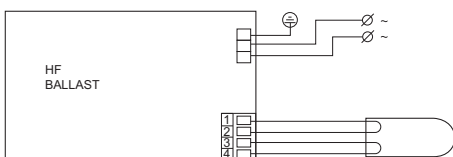



© 2014 Koninklijke Philips N.V. (Royal Philips)
All rights reserved.

Specifications are subject to change without notice. Trademarks are the property of Koninklijke Philips N.V. (Royal Philips) or their respective owners.

www.philips.com/lighting

2014, April 11
data subject to change